

Neon® DIS
Krypton® DIS



Sigrist Doku 13749E Vers. 2

Errata Instruction Manual

AquaDMS disinfection measurement

SIGRIST-PHOTOMETER AG has the following additions to the Operating Instructions from Dr. A. Kuntze GmbH (Neon® DES and Krypton® DES):

SIGRIST-PHOTOMETER AG supports the following functions for chlorine measurement on the Neon® DES and Krypton® DES from Dr. A. Kuntze GmbH:

- Measurement of free chlorine, chlorine dioxide, ozone and hydrogen peroxide
- Neon® DES control unit
- Argon® Stabiflow measuring cell
- Zirkon® FTG temperature sensor
- Zirkon® DES chlorine sensor
- Outputs: 1 x 0/4 .. 20 mA, galvanically isolated
- ASR® automatic sensor cleaning

The purchase options in the following sections are **not** supported:

Section 14: Add-on Datalog

Section 17: Add-on Modbus RTU

Section 18: Add-on Controller

Section 19: Add-on Volume based dosing

Content

1.	Neon® and Krypton® DIS	8
1.1.	General and safety instructions	9
1.2.	Warranty conditions	9
1.2.1.	Transport damages	9
1.2.2.	Application	10
1.2.3.	Intended use	10
1.3.	Feature	12
1.4.	Technical Data Neon® DIS	15
1.5.	Measuring system Krypton® DIS	16
2.	Instructions for installation and connections	17
2.1.	Dimensions	17
2.2.	Installation panel-mounted housing	18
2.3.	Installation wall-mounted housing	18
2.4.	Connections	19
2.4.1.	Connection diagram	20
2.4.2.	SD card	21
2.5.	Measuring set-up	22
2.6.	Installation of Krypton®	23
3.	Operation	24
3.1.	Desktop	24
3.2.	Touch screen operation	24
3.2.1.	General	25
3.2.2.	Main menu	25
3.2.3.	Submenus	25
3.3.	Settings	25
3.4.	Menu overview – where to look?	28
3.5.	Menu appearance depending on code and options	31
4.	Code	32
5.	Mode	33
6.	Analog input – disinfection measurement	34
7.	Temperature measurement	35

8.	Menu Cal – Calibration – Des	37
8.1.	Calibration – Reference	37
8.2.	Calibration – zeropoint	38
8.3.	Calibration – info	39
9.	Digital inputs	40
10.	Test menu	41
11.	Memory	42
11.1.	Store and upload settings	42
11.1.1.	How to save settings	43
11.1.2.	How to load settings	44
11.2.	Software update	45
11.3.	How to save the diagnosis file	46
12.	System functions	47
12.1.	Language	47
12.2.	Time	47
12.3.	Display	48
12.3.1.	Settings	48
12.3.2.	Touch Cal –for instruments with touch screen	51
12.4.	Contact	52
12.5.	Event-related support	53
12.6.	Info	54
12.7.	Reset to factory settings	55
12.8.	Add-on activation	56
13.	Alarm relay	57
13.1.	Settings	57
13.2.	Alarm action	58
14.	Add-on Datalog	59
14.1.	View logged data	61
15.	Add-ons mA output	62
16.	Add-on ASR®	63

Content

17.	Add-on Modbus RTU	65
17.1.	How to read out data	65
17.2.	Communication parameters	66
17.3.	Registers	66
17.3.1.	How to read variables	67
17.3.2.	Measured values, controller outputs and status of digital inputs and outputs	68
17.3.3.	Event messages and calibration results	69
17.3.4.	Instrument data	72
17.3.5.	How to read and write parameter settings	73
17.3.6.	Units and texts	79
17.3.7.	Test functions	81
18.	Add-on Controller	82
18.1.	S1/S2 control – set-point configuration	83
18.1.1.	ON/OFF controller	83
18.1.2.	P controller	84
18.1.3.	PI controller	84
18.1.4.	PID controller	84
18.1.5.	3-point controller	85
18.2.	S1/S2 CONFIG – configuring the controller output	86
18.2.1.	CONFIG – pulse-pause or pulse-frequency for P/PI/PID	87
18.2.2.	CONFIG – Motor run time and minimum pulse for 3-point controller	87
18.3.	Configuration of the relays	88
18.4.	Start delay and dosage control	88
18.5.	Activating and deactivating the controller	89
18.6.	Relay display and manual operation of the control relays	89
18.7.	Automatic controller stop	90
19.	Add-on volume based dosing	91
19.1.	Dosing parameters	91
19.2.	Configuration of the dosing relay	92
19.3.	Pump relay	93
19.4.	Activating and deactivating the dosing	94
19.5.	Flow display	94
19.6.	Automatic dosage stop	94

20.	Operation and Maintenance of Neon® DIS and Krypton® DIS	95
20.1.	Start-up	95
20.2.	Maintenance – operation mode	95
20.3.	Maintenance of the measurement	96
20.3.1.	Cleaning of sensors	96
20.3.2.	Refilling the KCl vessel (with refillable sensors)	97
20.3.3.	Cleaning of assemblies, filters, etc.	97
20.3.4.	Calibration of the measurement	99
20.3.5.	Checking the gaskets	99
20.3.6.	Testing the safety features	99
20.3.7.	Exchange of consumables	99
20.4.	Restarting	99
20.5.	Decommissioning and disposal	100
20.6.	Facilitating functions	100
20.6.1.	Store and load settings via SD card	100
20.6.2.	Software update via SD card	100
20.6.3.	Test menu	100
21.	Trouble-Shooting	101
21.1.	Useful accessories for trouble-shooting	101
21.2.	Contact	101
21.3.	Diagnosis file	101
21.4.	Info	102
21.5.	Event messages	102
21.6.	Eventlog	102
21.7.	Event help	103
21.8.	Events with Popup messages	108
21.9.	Reset	109
	Index	110

1. Neon® and Krypton® DIS

1. Neon® and Krypton® DIS

are products by Kuntze Instruments GmbH which offer high quality and long-term reliability, made in Germany.

With its modular design, the Neon® instrument can be tailored to your application.

The entry-level version contains inputs for measurement and temperature, a digital input, and an alarm relay.

A set of codes allows access to different operation levels. If you want to ensure that only authorized personnel can operate the instrument, define an auto-lock time after which the code is reset to default setting.

Save energy with the Eco mode, in which the display illumination is deactivated after an adjustable interval.

The Neon® instruments have an SD card slot. You can store and load instrument settings, to duplicate software settings to additional instruments or to reinstall your settings after updates or repair. You can also use the SD card for software updates.

We have equipped the Neon® instruments with some very convenient features:

The touch screen is the perfect complement to the graphical operation and gives you shortcut access to important menus from the main display.

The information displayed on the screen can be defined by the user, adding for example control values, datalog status, – or maintenance information, such as the name and phone number of responsible facility personnel. In case of problems, the diagnosis function allows quick assessment of the situation.

Test functions make trouble-shooting and installation easier by providing manual operation of all digital and analog outputs.

The Neon® instruments are expandable through software add-ons and hardware modules. You can add:

- > A second digital input
- > Up to two analog outputs
- > A datalog function that stores data on the SD card
- > A PID controller with two control relays for concentration-based dosing
- > Volume based dosing with two relays and flow measurement
- > Modbus RTU interface
- > Our patented Automatic Sensor Cleaning feature ASR®

The measuring system Krypton® DIS supplements these instrumental advantages with a ready-to-use set-up of all necessary components: cable, sensor, assembly, connectors, etc. The assembly Argon® StabiFlow ensures stable flow in applications with changing pressure or water flow. It contains a multi-sensor for temperature and low-water alert, a filter, and a check valve. It is compatible with all our DIS-sensors and our patented automatic sensor cleaning ASR® which keeps the sensor electrodes clean and active even in high-pollution applications.

Control your water quality at any time, from any place, on any device. The solution is Kuntze Cloud Connect®

With Neon® and Krypton® DIS you have certainly made the right choice. On the following pages find out more about your disinfection measurement. If you have further questions or are looking for information not included in this manual or if you are interested in supplementing products such as sensors, just give us a call – we will be delighted to help you!

1.1. General and safety instructions

This operation manual applies to the following instruments

Instrument type Neon® DIS

SW version V 2.38

The manual contains technical information on installation, operation, and maintenance.

Keep this manual in a place where you can always look up the safety instructions and the information on handling and usage. According to DIN 61010 the manual is part of the product and has to be preserved as long as the instrument is used, and given to the new owner if the instrument is sold.

The instrument was designed, built, and tested according to the directives for electronic devices and has left our company in perfect working condition. To preserve this condition and to ensure safe operation, follow all instructions carefully and pay special attention to all warnings issued in this manual. If the instrument is visibly damaged or has been stored inappropriately or if there are any doubts concerning safe operation, shut it down and make sure it cannot be restarted.

You will notice that certain safety instructions are highlighted:

Warning **highlights instructions for the protection of people. Disregarding warnings may cause accidents and injuries!**

Attention **highlights instructions for the protection of the instrument and equipment. Disregarding these instructions may lead to damage or destruction of the instrument or equipment!**

Note **is used to highlight interesting details.**

1.2. Warranty conditions

We have to point out that the warranties specified in our trading conditions are valid only if the following conditions are met:

- > Installation and start-up by Kuntze personnel or trained and authorized technicians
- > Maintenance of instrument and peripheral equipment according to the instructions of this manual
- > Use according to the designation specified on the following pages
- > Use of original accessories and spare parts only
- > Observance of operation conditions and settings according to this manual

Warranty is void if any one of the conditions listed above is disregarded.

1.2.1. Transport damages

Please check for damages immediately after delivery and report any damages within 24h to the delivering company. Never work with a damaged instrument!

1. Neon® and Krypton® DIS

1.2.2. Application

Neon® instruments can be used for the following measurements:

Instrument	Measurement
Neon® pR	pH or ORP and temperature
Neon® DIS	Free Chlorine, Chlorine dioxide, Ozone, Hydrogen peroxide, or Total Chlorine and temperature
Neon® EC IL	Inductive conductivity and temperature
Neon® EC	Conductive conductivity and temperature
Neon® TCL	Measurements with sensors that supply a standard signal such as 4...20mA. Display in mg/l, ppm, or NTU
Neon® GAS	Gas monitoring for Chlorine, Chlorine dioxide and Ozone gas

In many applications, the measured parameters are used for control purposes. Neon® instruments can be equipped with a controller with two set points. With this you can control actuators such as dosing pumps or valves to add chemicals until the desired set point is reached. Alternatively, the measured signal can be used as input for an external controller via the instruments' interfaces.

Applications are for example neutralisation, detoxication, drinking water treatment, industrial waste water, process water, disinfection, and process control.

As a safety precaution, measurement and calibration are checked for failure by the instrument. Failures are indicated on the display via text messages that are stored in an eventlog and via the alarm relay and, if activated, as 22mA current via the analog output.

If the failure makes control unreliable, the controller is automatically switched off until the failure has been taken care of.

Warning **The instrument checks the input signals, calibration results, and the water flow, if a flow sensor is connected. It cannot detect erroneous settings or failures in the treatment system, nor can it check for plausibility! The safety of the system of which the instrument is part of lies within the reach of responsibility of whoever built the system!**

1.2.3. Intended use

Use these instruments only for the monitoring and control of water – or, in case of gas monitoring instruments, of ambient air.

Use only sensors, assemblies, and accessories made by Kuntze, and make sure that they fit your application. Make sure that the required measuring conditions such as flow, pressure, temperature etc. are constantly maintained.

1. Neon® and Krypton® DIS

The measuring system Krypton® provides ideal conditions for the measurement. With the assembly Argon® StabiFlow it maintains a constant flow independent of pipe pressure. Instructions within this manual that exceed the operation of the instrument refer to the Krypton® system.

Install and operate the instrument according to this manual. Carry out all steps described, and check all measurements and settings before you activate the controller.

Use all available safety measures such as the alarm relay, the 22mA alarm current, the dosage control, and the low-water indication.

Regularly check that all safety measures are in good working condition!

Warning **The protection built into the instrument is impaired if it is not used as intended!**

1. Neon® and Krypton® DIS

1.3. Feature

Basic instrument DIS	
Measuring ranges	
Free Chlorine/Chlorine dioxide/ Total Chlorine	Up to 1000µg/l, up to 5.00 / 10.00 / 20.00 mg/l Cl ₂ or ClO ₂
Ozone	Up to 1000µg/l, up to 5.00 / 10.00 mg/l O ₃
Hydrogen peroxide	Up to 30.00 mg/l H ₂ O ₂
Temperature	-30°.. +140°C (-22°..+284°F)
Display	Measured value and temperature with units Additional information selectable: contact data, SD card status, mA output, control variable, or relay status
Operation	Touch screen
Calibration	1-point calibration against reference, zeropoint calibration possible List of the last 10 calibration results
Measurement	Free Chlorine, Chlorine dioxide, Ozone, Hydrogen peroxide or Total Chlorine selectable via menu, display as µg/l, mg/l, ppb or ppm
Averaging	Off / low / medium / high, selectable via menu
Temperature measurement	With Pt100 or Pt1000, 2-wire or 3-wire connection
Temperature compensation	Automatic or manual
Relay 3 – alarm relay	Potential-free contact 6A, 250 V, max. 550VA Alarm events selectable via menu Min. and max. limits and adjustable delay
Digital input 1	For external controller stop, low-water indication, or level monitoring Display text can be selected according to intended function Input can be set to N/O or N/C contact via menu
Test menu	Operation of relays and outputs
SD card	To load and save settings To save the diagnosis file To load software updates
Auto lock	Resets the code to 0000 after a defined period of time

Basic instrument DIS	
Eco mode	Saves energy by deactivating the display illumination after an adjustable interval
Eventlog	Stores up to 100 events
Event help	Provides help for current events
Add-on	Functions can be added via code
Add-ons	
Digital input 2	For external controller stop, low-water indication, or level monitoring Display text can be selected according to intended function Input can be set to N/O or N/C contact via menu Flow measurement for volume based dosing
Analog output 1	0/4.. 20 mA galvanically isolated, max. load 500 Ohm 22 mA alarm current selectable via menu To read out measured value, or temperature, or controller output Scaleable within the measuring range
Analog output 2	0/4.. 20 mA galvanically isolated, max. load 500 Ohm 22 mA alarm current selectable via menu To read out measured value, or temperature, or controller output Scaleable within the measuring range
Data log	Measured value, temperature, input signal and control variable selectable Interval adjustable between 1 second and 24 hours Ring or Stop mode
Digital interface	Modbus RTU, 19200 bps, 8 Bit, 1 Stopp-Bit, even parity
Automatic sensor cleaning ASR®	Selectable via menu, start time and interval interval (0-7x/week) adjustable, baseload selectable via menu

1. Neon® and Krypton® DIS



Add-on PID controller

Controller options	On/Off controller with adjustable hysteresis P/PI/PID controller as Pulse-Pause, Pulse-Frequency, or continuous controller 3-point controller
Set points	2 set points with adjustable acting direction (except 3-point controller)
Relays	2 potential-free contacts 6A, 250 V, max. 550 VA
Hysteresis	Adjustable within the measuring range
Proportional range (X_p)	Adjustable within the measuring range
Integral time (T_N)	0 ... 2000 seconds
Derivative time (T_V)	0 ... 2000 seconds
Min. pulse	0.2 ... 9.9 seconds
Pulse+Pause time	2 ... 99 seconds
Max. frequency	1 ... 7200 pulses/h
Start delay	0 ... 200 seconds
Dosage monitoring	0 ... 99 minutes

Add-on volume based dosing

Dosing	0,000 to 9,999 l reagent per l of water
Flow measurement	0,000 to 9,999 l/Imp
setpoint	adjustable within the measuring range
Concentration	0.0...999.9l/h
Min. Pulse	0.2...9.9 seconds
Pulse + pause time	2...99 seconds
Max. frequency	1...7200 pulses/h
Relays	2 potential-free contacts 6A, 250 V, max. 550 VA Relay 1 – control variable Relay 2 – circulation pump

1.4. Technical data Neon® DIS

Feature	Neon® panel mounted	Neon® wall mounted
View		
Installation	panel-mounted housing	wall-mounted housing
Dimensions	138 x 138 x 83 mm	144 x 144 x 156 mm
Weight	0.6 kg	1.0 kg
Connections	Cable inlet: 2x M16, 2x M12 + optionally: 2x M12 and 1x M25 Terminals Basic function: rigid/flexible 0.2-2.5 / 0.2-2.5 mm ² Measurements: rigid/flexible 0.2-1 / 0.2-1.5 mm ²	
Protection class	Front IP54	IP65
Power supply	85.. 250 V AC, +6/-10%, 40.. 60Hz Option: 24 V DC	
Power consumption	10 VA	
Contact rating	3 relays, potential-free N/O contacts, max. 250 V, 6A, 550 VA	
Operation temperature	0.. 50°C	
Storage temperature	-20.. +65°C	
Rel. Humidity	max. 90% rH at 40°C (non-condensing)	

1. Neon® and Krypton® DIS

1.5. Measuring system Krypton® DIS

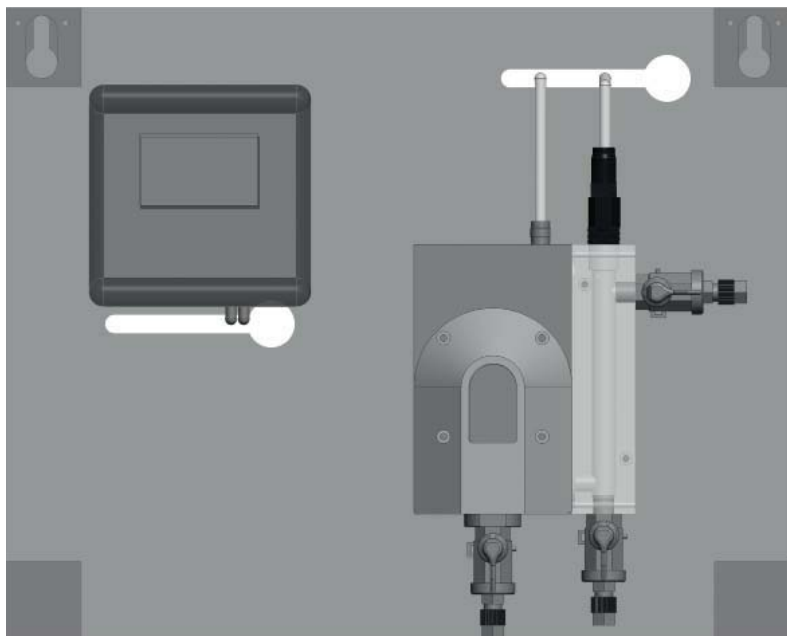

Assembly Argon® StabiFlow	Inlet and outlet with stop cocks, sampling point, holder for one Des sensor, flow control, filter, check valve, multisensor for flow monitoring and temperature
Sensor Zirkon® DIS	Gold/Gold for Chlorine, Chlorine dioxide, Ozone Platinum / platinum for Peroxide Platinum / carbon for Chlorine in salt water InnoDisk®/ platinum for Total Chlorine
Cable for Zirkon® DIS	
Multisensor Zirkon® FTG	Pt100 3-wire connection, flow monitoring, ground
Automatic sensor cleaning ASR®	Activated via menu, start time and interval (0-7x/week) selectable, base-load dosing selectable via menu
Operation temperature	0..50°C (32°..122°F)
Storage temperature	-20..65°C (-4°..149°F), exception sensor: 0..30°C (32..86°F)
Water supply	35...400l/h
Water pressure	Max. 6 bar at 20°C (max. 87 psi at 68°F)
Min. conductivity	>200µS/cm
pH range	Free Chlorine: pH 6...8 constant Chlorine dioxide / Ozone / Hydrogen peroxide: pH 6...9 Total Chlorine: pH 6...10

2. Instructions for installation and connections

Attention Install the instrument in a place where it is not put under mechanical or chemical strain!

Note Mind the protection class!

2.1. Dimensions

Picture 1 Dimensions Neon® panel-mounted housing

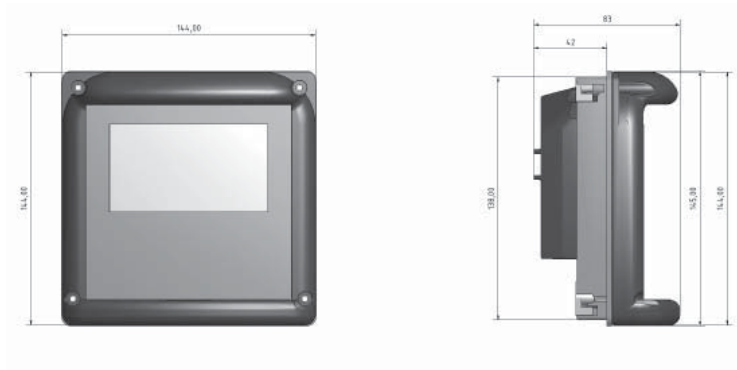

Picture 2 Dimensions Neon® wall-mounted housing

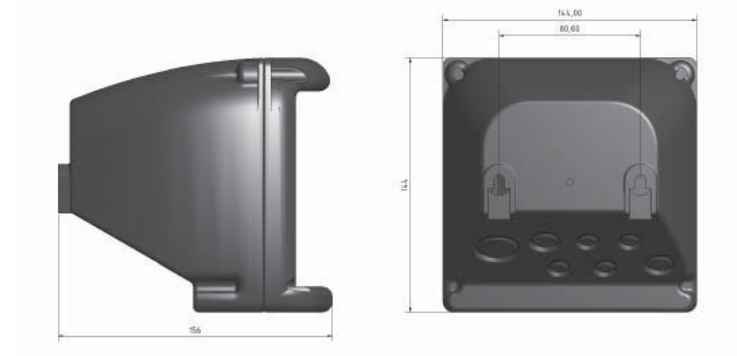

Picture 3 dimension Krypton® DIS measuring board

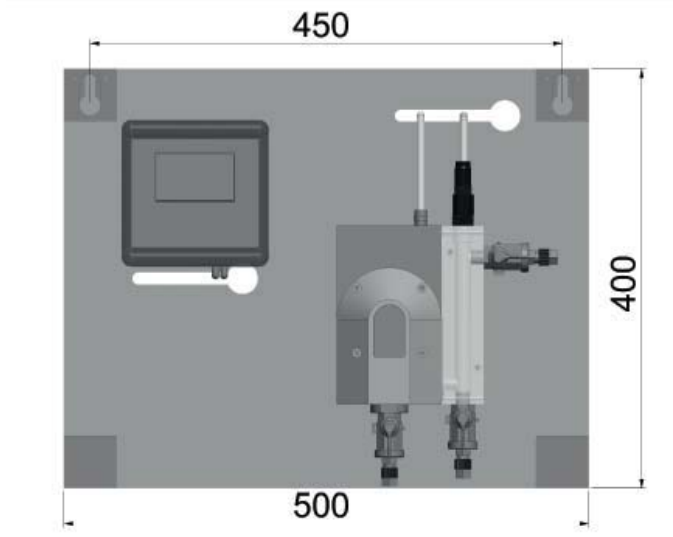

2. Instructions for installation

2.2. Installation panel-mounted housing



Prepare an opening of 138 x 138 mm. Clip the installation frame into the opening.

(Max. wall thickness: 5 mm)

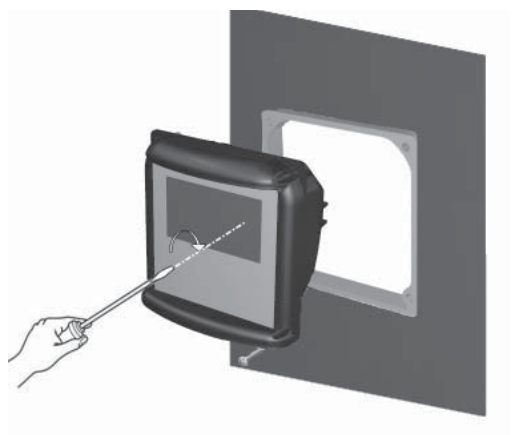

Place the instrument inside the frame and secure it with the M4 x 25 screws. Tighten the screws until the instrument is firmly fixed.

Attention To preserve the protection class, the flat gasket of the housing and the sealing ring of the frame must be used!

2.3. Installation wall-mounted housing



Pierce the pre-cut openings of the housing for as many cable glands as you wish to use and remove any remaining pieces from the openings.

Place the installation plate into the back frame and screw in the cable glands.

Drill two holes at 80 mm horizontal distance. Screw two screws into the holes and mount the instrument on the screws.

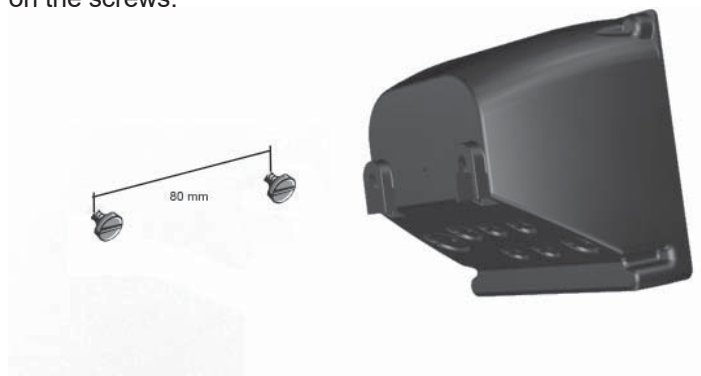

Or you can open the instrument and put the screws through the holes at the back of the instrument. Mind to replace the covers before closing the instrument.

2.4. Connections

A detailed connection diagram can be found on the following pages.

Before connecting the power supply check the information on the instrument label!

Warning **Input, output, and control cables must be installed separate from each other and especially apart from power lines!**

For inputs and outputs use screened cables, and connect the screens on one side only.

The measurements are interference-sensitive. Use only our special cables with a very high insulation and keep the distances as short as possible.

For the connection of temperature sensors use a low-resistance cable with a large diameter.

When using the relays, mind that with inductive loads, interference must be suppressed. If that is not possible, the relay must be protected at the terminal block by a resistance-capacity filter or, in case of direct current, by a free-wheeling diode.

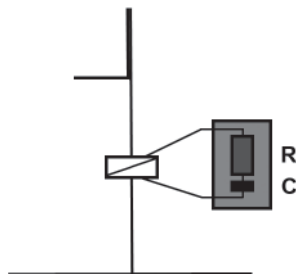



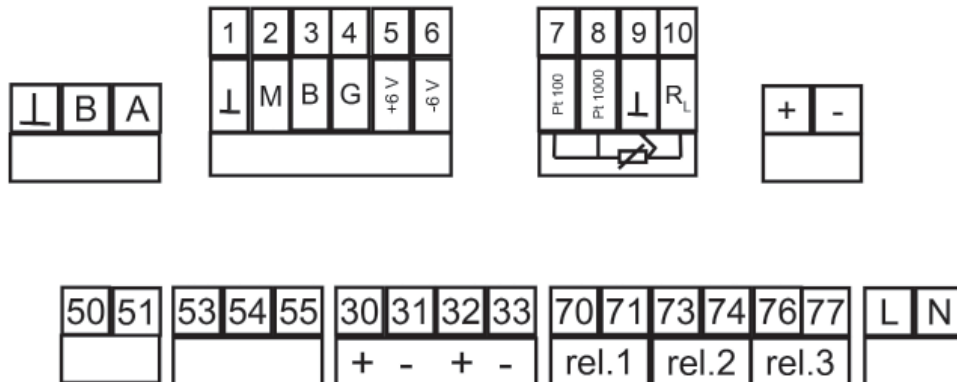

Current up to	Capacitor C	Resistance R
60 mA	10 nF 260 V	390 Ohm 2 Watt
70 mA	47 nF 260 V	22 Ohm 2 Watt
150 mA	100 nF 260 V	47 Ohm 2 Watt
1,0 mA	220 nF 260 V	47 Ohm 2 Watt

2. Instructions for installation

2.4.1. Connection diagram

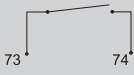

Connection	Terminals	Notes
Des sensor	1-4	1 = screen 2 = measuring electrode = brown 3 = reference electrode = white 4 = counter electrode = blue
Pt 100	7,9+10	7 = T1 (Pt 100) 9 = T2 (Pt 100) 10 = R _L – for 3-wire connection/cable compensation*
Pt 1000	8,9+10	8 = T1 (Pt 1000) 9 = T2 (Pt 1000) 10 = R _L – for 3-wire connection/cable compensation*
Digital input 1	50+51 	50 = +, 51 = -, low water, level monitoring, or controller stop
Digital input 2	53-55 	53 = +, 54 = -, low water, level monitoring, or controller stop volume based dosing 53 = Signal 54 = GND 55 = + 15 VDC
Analog output 1	30+31	30 = +, 31 = -, max. load 500 Ohm
Analog output 2	32+33	32 = +, 33 = -, max. load 500 Ohm
Relay 1	70+71 	Controller: control variable set point1 volume based dosing: control variable set point 1 Max. 2 A, AC 250 V/550 VA DC 30 V / 60 W

Connection	Terminals	Notes
Relay 2	73+74 	Controller: control variable set point 2 (with 3-point controller control variable set point 1) volume based dosing: circulation pump Max. 2 A, AC 250 V/550 VA DC 30 V / 60 W
Relay 3	76+77 	Alarm relay Max. 2 A, AC 250 V/550 VA DC 30 V / 60 W
Power supply	L+N	85-265 V AC
Power supply 24 V DC	+/-	24 V DC
Modbus RTU	A+B ⊥	A = + B = - ⊥ = Screen

Add-ons (marked in grey)

Controller or volume based dosing, second digital input, up to 2 mA outputs, data logging, and RS 485

*For 2-wire-connection there should be a jumper between terminal 9+10

2.4.2. SD card

You will find the SD card slot at the back of the housing.

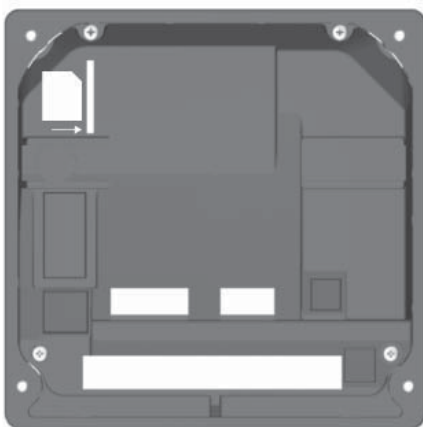

Press the SD card – with angled edge top right – into the slot until it is into place.

By pressing the SD card the mounting is loose and the SD card will be ejected.

2. Instructions for installation

Note **Never remove the SD card while the logging is running! Always set the mode to OFF (not stop!) before removing the card. Otherwise data loss might occur, and an error message will appear.**

2.5. Measuring set-up

Besides the instrument you need a sensor suitable for the instrument and the application, a cable to connect the sensor to the instrument, and an assembly to install the sensor in your process. The task of the assembly is to provide the sensor with water in a precise way necessary for a reliable measurement.

An ideal set-up represents our measuring system Krypton[®], which additionally provides flow control, a filter, and a multisensor for temperature and flow monitoring.

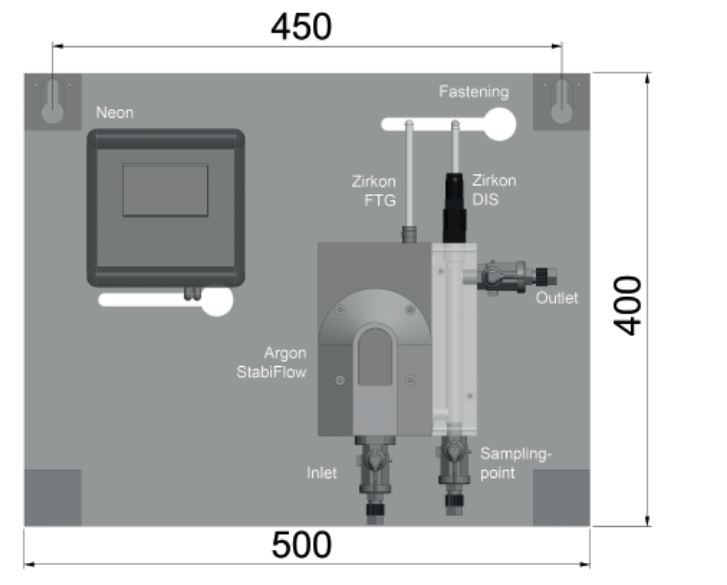

2.6. Installation of Krypton®

The measuring system is delivered ready-to-use and mounted on a PVC board. The board comes with two fastenings to be mounted on a wall. Drill two holes at 450 mm horizontal distance. Insert the plugs included in the delivery, screw the screws into the holes and mount the instrument on the screws via the fastenings.

Water connection

Connect the water inlet at the left stop cock at the bottom of the assembly, and the outlet at the stop cock on the right upper corner. Water has to be supplied at 35...400l/h. The outlet can be an open outlet, or the water can be redirected into a pipe or basin.

Note **Mind that the quality of your measured values strongly depends on how well the measured water matches the water you want to control. Do not take the measured water directly behind the dosing points or from stagnant sections, and avoid long and time-consuming tube connections to the measuring system.**

Take the Des sensor out of its container and remove the cap. At works the sensor is installed in a KCl container that has to be removed prior to installation.

Note **We advise to keep the KCl container, closed tightly, and to store the sensor in the container when it is not used.**

Install the sensor in the assembly and connect the cable.

Attention **Tighten the sensor only hand-tight! Do not use heavy tools to avoid damage to the sensor!**

Before you open the inlet, make sure that the stop cock of the sampling point is closed and the outlet is open. For start-up, see chapter Operation and maintenance.

3. Operation

3. Operation

When the power is switched on, the instrument initialises. During that process, the time is displayed.

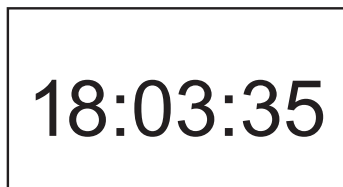

After approx. 20 seconds the process is finished, and the measured values are displayed.

3.1. Desktop

With factory settings, the display shows at the top the instrument name and the time, followed by the current measured value and the temperature.

In the bottom line, the triangular symbol shows the way to the menu (key DOWN, or just touch the triangle if you have a touch screen instrument). On the right side of the bottom line, current events are displayed.

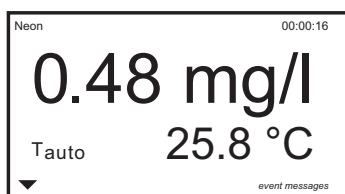

3.2. Touch screen operation

Neon® touch is operated via touch screen. The screen is of the resistive type, with the advantage that a touch is recognized via pressure – it can be operated even with gloves, and does not respond to mere splashes of water. Press your finger on the screen gently but firmly, and keep the pressure until the instrument shows that the touch has been recognized.

In the desktop (display of the measured values), touching various areas of the screen gives access to different functions and submenus:



Touch

- > **text** to switch to another desktop design
- > **time** to enter the time setting menu
- > **event message** to get suggestions for trouble-shooting
- > the **triangle** to enter the main menu

Note

Mind that access might be limited via code. If the current code does not permit access to a selected area, the touch will only yield an empty display. In that case you have to enter the main menu and set a valid code first (0202 for the calibration level, 1612 for full access)

3.2.1. General

All submenus show on the right side of the top line two symbols:



Home – Touching this symbol takes you back to the desktop from any position



ESC – Touching ESC takes you back to the previous menu.

3.2.2. Main menu

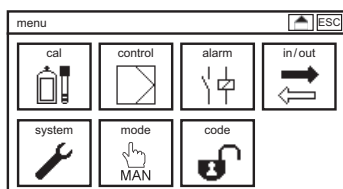

Press the triangle on the left side of the bottom line of the desktop to enter the main menu. In the main menu, select submenus by touching the corresponding symbols.

3.2.3. Submenus

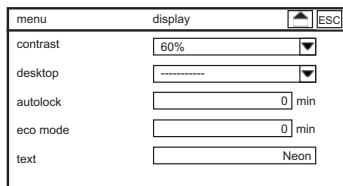

In submenus you will find on the left side the parameters and on the right side the corresponding settings. If the submenu contains more parameters than can be shown, a scroll bar on the right side gives access to the parameters currently not shown.

Move the scroll bar by pulling the bar with your finger or by touching the triangles at the top and bottom of the bar.

3.3. Settings

Parameters are set either by entering a value via keyboard or by selecting a setting from a drop-down list or by activating or deactivating an item from an action list, depending on the nature of the parameter.

Drop-down lists

Drop-down lists appear whenever you have to select a single option from a variety of options, for example when you choose a display design:

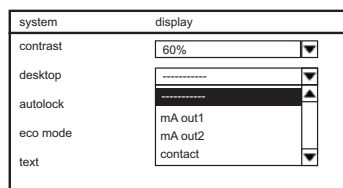

Drop-down lists are indicated by a triangle on the right side of the parameter setting.

Move the cursor with the UP and DOWN keys in the submenu until the setting of the desired parameter turns black. If you press OK, the drop-down list appears. Move the cursor with UP and DOWN keys in the list until the desired parameter turns black. Press OK to choose the parameter.

Open the drop-down list by touching the triangle. A list of possible settings appears. Select the desired setting via touch.

3. Operation

Press ESC if you want to cancel and leave without changing the setting.

Action lists

Action lists appear whenever you can select more than one option from a list, for example alarm actions:

alarm	action
<input checked="" type="checkbox"/>	zeropoint
<input checked="" type="checkbox"/>	slope
<input checked="" type="checkbox"/>	overrange
<input checked="" type="checkbox"/>	lower limit
<input checked="" type="checkbox"/>	upper limit
<input checked="" type="checkbox"/>	digital input 1
<input checked="" type="checkbox"/>	digital input 2
<input type="checkbox"/>	dosage check

Action lists contain all selectable items. On the left side, each item has a box that can be ticked.

With key pad instruments, scroll through the options with the UP and DOWN keys until the desired option turns black, then press OK to tick the box or to remove the tick. With touch screen instruments, press the desired option with your finger to tick or untick its box.

Note Options that are not activated in your instrument are crossed out and cannot be ticked.

Neon®'s support with the settings:

Parameters that do not fit to previous selections are hidden, e. g. in the TEMP menu correction and manual Temperature depending on the mode.

in/out	temp
type	Pt100
mode	manual
manual value	25.0 °C
reference value	25 °C
temp. coeff.	0.0 %/K

in/out	temp
type	Pt100
mode	Auto
correction	0.0 °C
reference value	25 °C
temp. coeff.	0.0 %/K

Entering a value / keyboard

For settings of a freely adjustable parameter, like limit values or contact data, a keyboard appears if you select the input field – with key pad instruments with the UP and DOWN keys and OK, with touch screen instruments by touching the settings box of the parameter.

On the right side of the keyboard, four function keys are shown:

- > The upmost function key shows „123“ or „abc“ and allows changing from characters to numbers and vice versa.
- > The „C“ (clear) key erases the last input
- > The „AC“ (all clear) key erases the complete input
- > The „OK“ acknowledges the selection

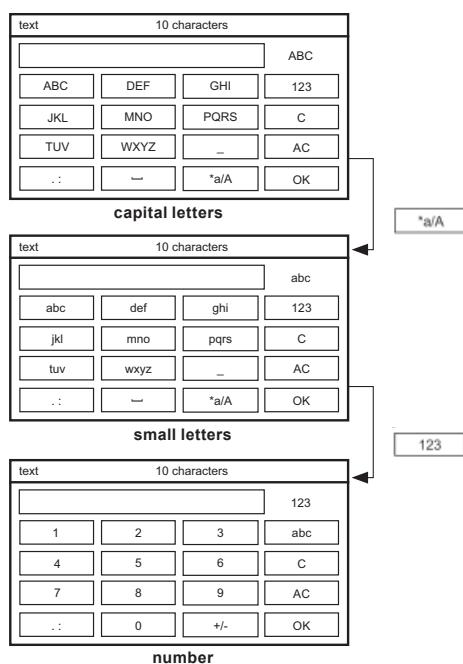

Note With numerical parameters, the keyboard automatically shows only numbers.

Navigate through the keyboard by pressing the UP and DOWN keys. By pressing OK you choose the inverted field. If a key represents several characters, touch it twice for the middle character or three times for the right character. With touch screen operation simply select numbers and characters by pressing the field.

Example: abc key

Key pad instrument

OK key once: a appears

OK key twice: b appears

OK key three times: c appears

Touch screen instrument

abc key touch once: a appears

abc key touch twice: b appears

abc key touch three times: c appears

Touch OK when the input is complete. Now the instrument checks if the input is within the allowed limits. If it is, the new value is stored, and the setting is finished. The keyboard disappears.

If the value does not lie within the allowed limits, the value is not stored. The input field turns dark, and the keyboard remains open until you enter a correct value or cancel the setting and touch ESC or home.

Note For maximum comfort the instrument adds zeros automatically. An input of pH 4, for example, is automatically turned into 4.00, and an input of 1 for the datalog interval is automatically interpreted as 00:00:01 (hours:minutes:seconds). Unfortunately, for date, code, add-on codes, text, and contact data, this support is not feasible.

3. Operation

3.4. Menu overview – where to look?

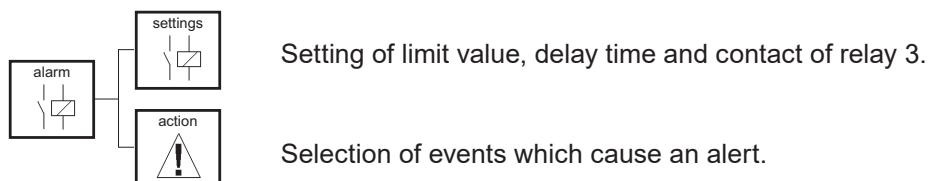
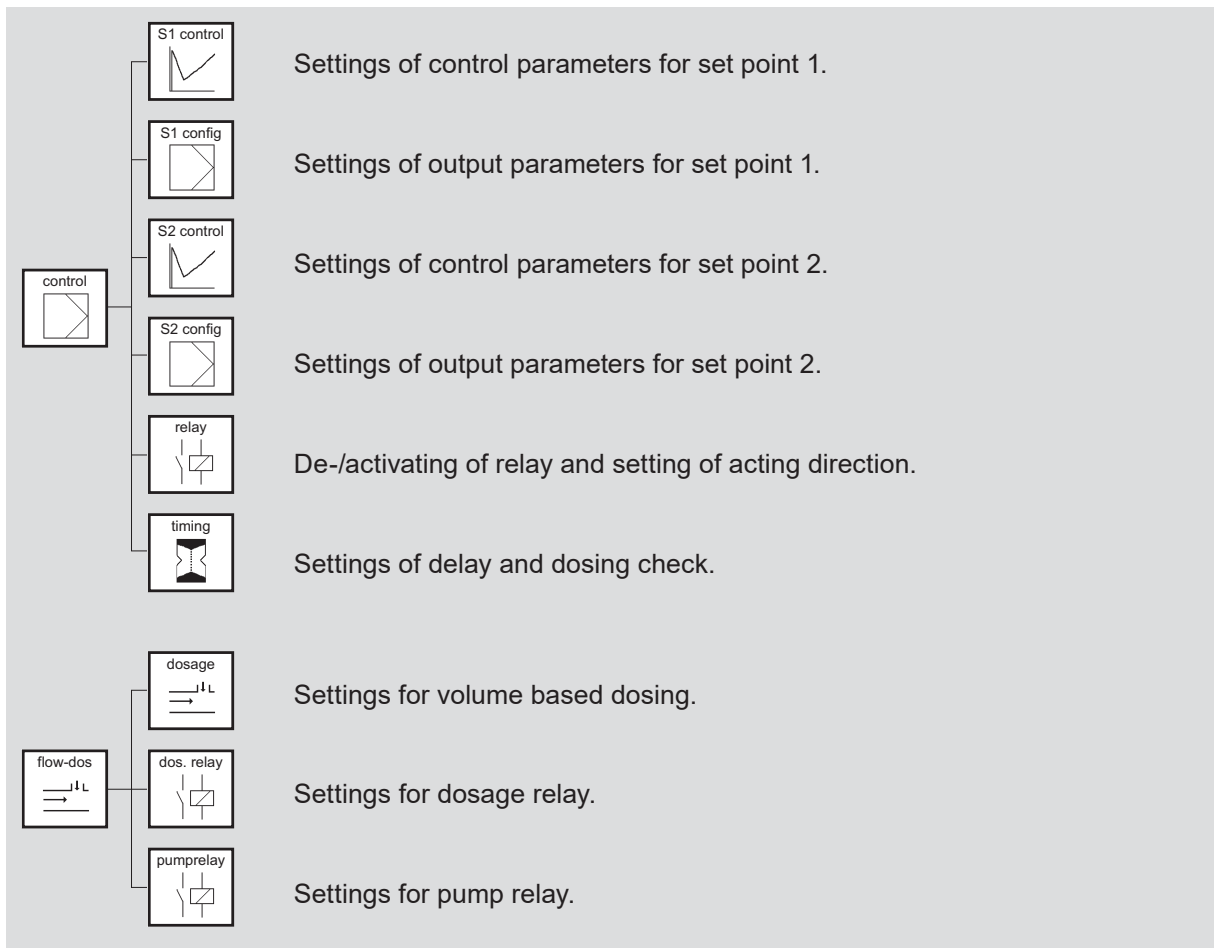
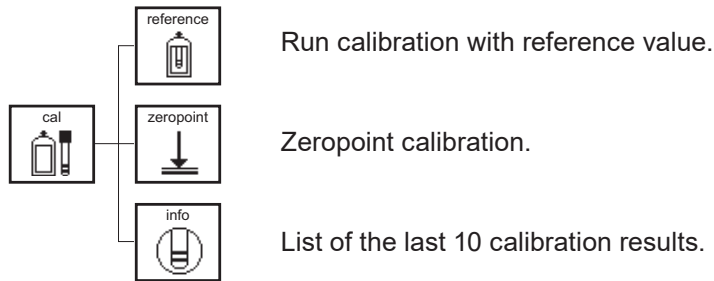

Add-ons (marked in grey)

Controller or volume based dosing, second digital input, mA output, Datalogger and Modbus RTU.

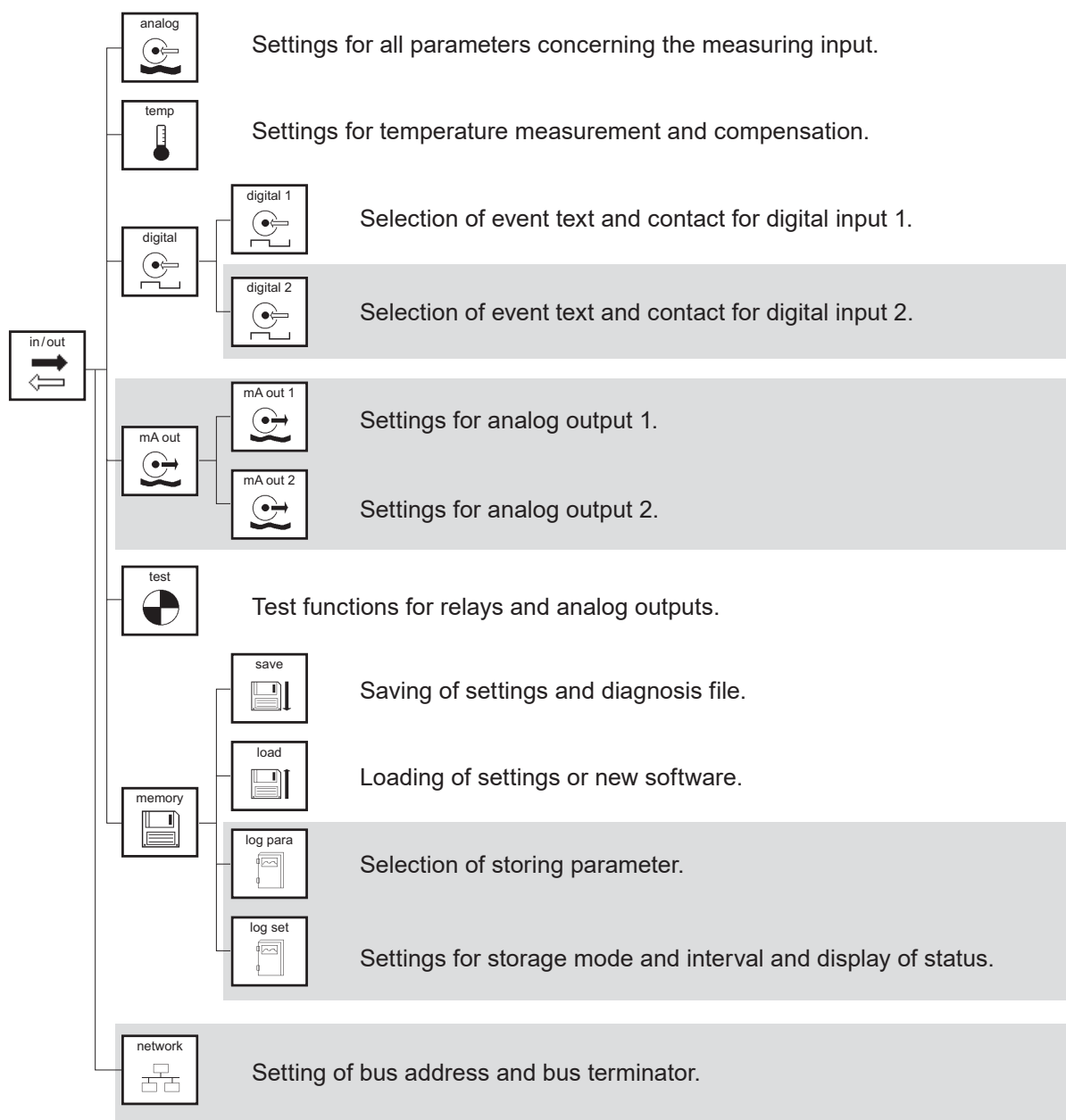

Add-ons (marked in grey)

Controller or volume based dosing, second digital input, mA output, Datalogger and Modbus RTU.

3. Operation

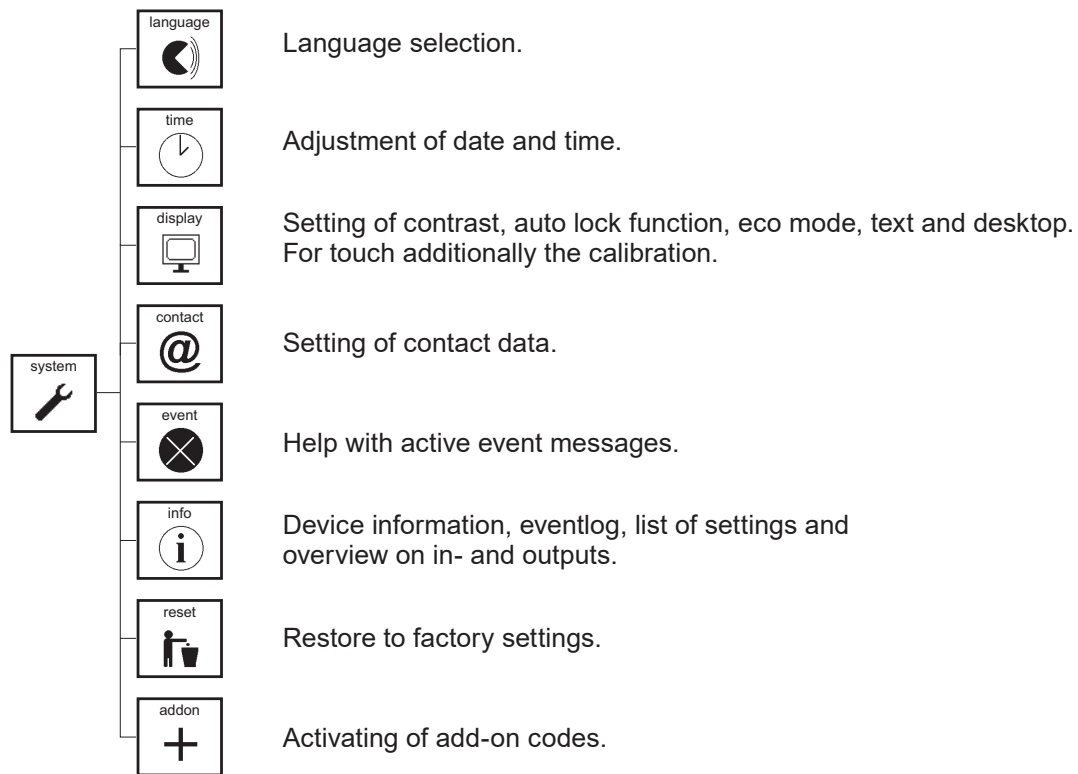

Selection of device mode: Man, Hold or Auto (Auto only available for add-on controller or volume based dosing).



Entering a code.

Add-ons (marked in grey)

Controller or volume based dosing, second digital input, mA output, Datalogger and Modbus RTU.

3.5. Menu appearance depending on code and options

The main menu and the submenus appear different, depending on code, add-ons, and settings.

No valid code

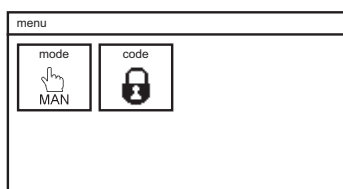

If no valid code is set, the main menu shows only two symbols, one to enter another code, and the other to stop the controller.

When the code is set to 1612 to give full access to all functions, the main menu shows all functions of the instrument. In the entry-level version the main menu shows six symbols. In the maximum version with all available add-ons, the main menu contains seven symbols.

Entry-level version

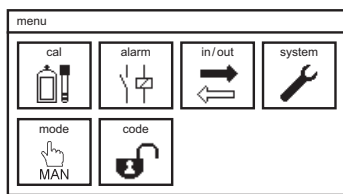

Maximum version

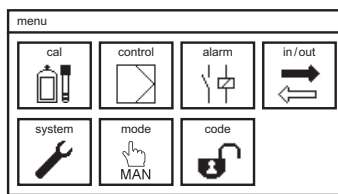

With code 0202, access is restricted, and the number of symbols decreases.

Add-ons (marked in grey)

Controller or volume based dosing, second digital input, mA output, Datalogger and Modbus RTU.

4. Code

4. Code

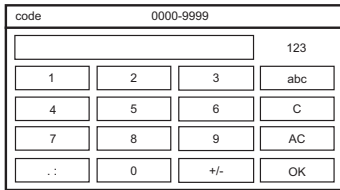
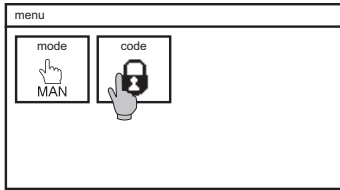

To enter a code, select the symbol CODE from the main menu, and enter the code via the keyboard.

The Neon® instruments have two access levels:

- > Calibration level code: 0202
On this level you can calibrate, save settings, events and the diagnosis file, and view various settings.
- > Full access code: 1612
On this level you can enter and change all functions and settings.

If the full access code is set, the CODE symbol in the main menu shows an open lock instead of a closed one.

Invalid code or calibration level

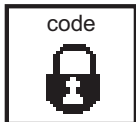

Full access

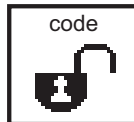

Autolock function

On delivery, the autolock function is deactivated. If you activate it via menu, the code is reset to 0000, to prevent unauthorized operation, after a defined interval without operation, or whenever the power supply was cut off. For more information, see the chapter "System functions".

5. Mode

There are two, with the option controller three modes of operation. To change the operation mode, select the symbol MODE. The symbol changes according to settings.

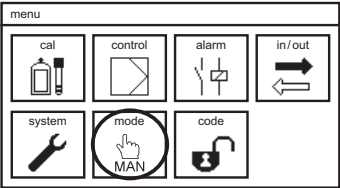
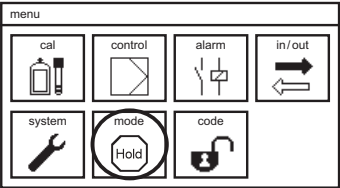
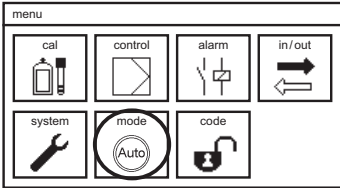
MAN	Hold	Auto
		
<ul style="list-style-type: none"> > Desktop display active > Alarm relay active > Test functions active > Limits active > Data log active > mA outputs active > Controller OFF > Modbus RTU active 	<ul style="list-style-type: none"> > Desktop display active > Alarm relay deactivated > Test functions deactivated > Limits deactivated > Data log on HOLD > mA outputs on HOLD > Controller OFF > Modbus RTU on HOLD 	<ul style="list-style-type: none"> > Desktop display active > Alarm relay active > Test functions deactivated > Limits active > Data log active > mA outputs active > Controller ON > Modbus RTU active

Note **The instrument shows always only the features that you have purchased. In the entry-level version, the instrument contains the desktop, the alarm relay, the test functions, and the limits.**

In operation mode auto Neon® stops automatically the controller if

- > the digital input switches (low water, level or ext. Controller stop)
- > there is no measuring value (check measuring input, check temperature input)
- > dosage check is activated
- > by Neon® DIS during automatic cleaning

6. Analog input

6. Analog input – disinfection measurement

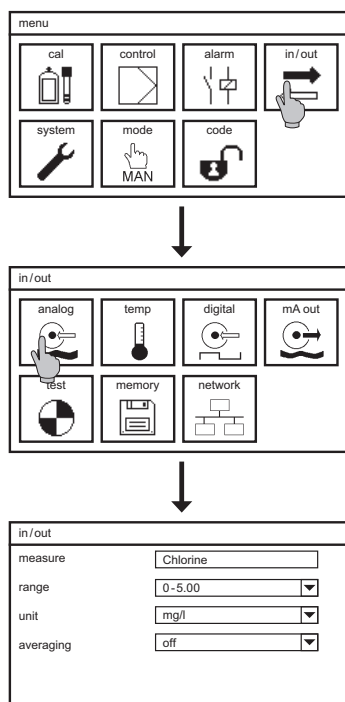

Select the symbol IN/OUT in the main menu and then the symbol ANALOG. A submenu opens, showing four drop-down lists.

In the submenu ANALOG you can select parameter and measuring range and, for mg/l ranges, switch the display unit from mg/l to ppm. Additionally, you can activate a suitable averaging level.

Measure

To select the parameter, select Chlorine, Chlorine dioxide, Ozone, Hydrogen peroxide, or Total Chlorine.

Warning

Before connecting the sensor choose first measuring parameter and range. Otherwise a depolarisation takes place which can last a few minutes up to a few hours.

Measuring range

Depend on the parameter you can select different measuring ranges:

- > Chlorine, Chlorine dioxide, Total Chlorine: Up to 1000 µg/l, up to 5.00 / 10.00 / 20.00 mg/l
- > Ozone: Up to 1000 µg/l, up to 5.00 / up to 10.00 mg/l
- > Hydrogen peroxide: Up to 30.00 mg/l

Warning

Whenever you change the measuring range, the instrument automatically changes the settings for current outputs, controller, and limits. Check these settings after changing the measuring range!

Display unit

Here you can switch from mg/l to ppm and vice versa and for the 0-1000 measuring range from µg/l to ppb and vice versa.

Averaging

To activate the averaging function, select:

- > OFF: no averaging
- > low: mean of 5 values
- > medium: mean of 10 values
- > high: mean of 20 values

7. Temperature measurement

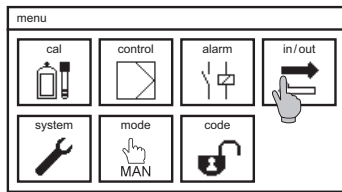

All settings concerning temperature measurement and compensation are found in the submenu IN/OUT → TEMP. Select the symbol IN/OUT in the main menu, and TEMP in the submenu.

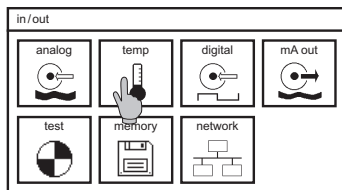

Type

Select Pt100 if you have connected a Pt100, or Pt1000 if you have connected a Pt1000. Other temperature sensors cannot be used.

Note

You can connect temperature sensors with 2-wire or 3-wire connection. If you use 3-wire connection, make sure that your sensor supports this type of connection.

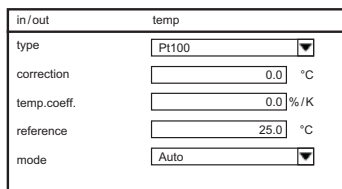

Correction

If the sensor is connected with a 2-wire cable, slight deviations might occur between measured and real temperature. Check the temperature once during installation, and calibrate the temperature measurement if necessary by entering a correction value between -10°C and +10°C (14°F and 50°F).

Note If the mode is manual the input for the correction value is hidden.

Temperature coefficient

Via the temperature coefficient you can adjust the compensation. The coefficient defines the amount of compensation as % correction per degree and depends on temperature and concentration. For many applications, a coefficient of 2%/K has proved advantageous. For small concentrations and temperatures close to 25°C (77°F) the setting can usually be left at 0%/K.

Note Since large temperature fluctuations are rare in disinfection applications, the main role of temperature compensation is the correct interpretation of low slope values in cold water to prevent slope error messages

7. Temperature measurement

Reference

The reference temperature is the temperature to which the values are compensated.

Mode

In the automatic mode, the measured temperature values are used to compensate the temperature influence on the measurement, and in the manual mode, a manual temperature setting is used. In the automatic mode, the measured temperature is displayed on the desktop and given out via analog and digital outputs. In the manual mode, the manual temperature is displayed and given out.

Note **On the desktop is shown whether the shown value is set manual (Tman) or measured (Tauto).**

Manual value

Enter the temperature of your solution for manual compensation. If you want to deactivate temperature compensation, set the manual value to the same value as the reference temperature and set mode to manual.

Note **If the mode is auto, the input for the manual value is hided.**

8. Menu Cal – Calibration – Des

Set the controller to MAN or HOLD: MAN stops the controller, all other functions are still active. HOLD stops the controller, all outputs are frozen to the last value and the alarm relay is deactivated.

A water sample is taken at the outlet of the assembly, and the disinfectant concentration in that sample is determined by a reference method. Find more information on that in the chapter Operation and maintenance.

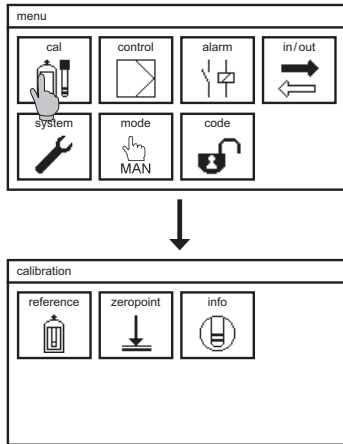

Select the symbol CAL to enter the submenu calibration. Here you find three symbols: REFERENCE, ZEROPOINT, and INFO.

8.1. Calibration – Reference

Note You can leave the calibration menu any time with ESC, and with touch screen operation also with the HOME symbol.

- > Select the symbol REFERENCE to start the calibration.

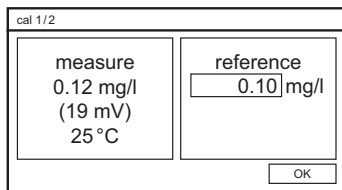

- > Take a water sample from the outlet of the assembly or at the sampling point, and determine the disinfectant concentration with a comparison method. Enter this value as Reference.
- > With OK you execute the calibration and reach the info screen, showing the results of the calibration.

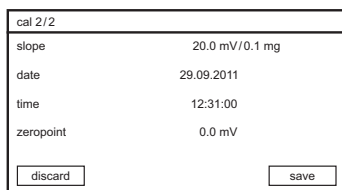

- > With the SAVE button you store the results. With DISCARD you reject the results and keep the previous calibration values.

Note If the slope is insufficient, an event message is displayed. If the calibration process has been carried out properly and correct, this message indicates that the sensor is worn out and has to be replaced as soon as possible. Refer to the eventlog or the chapter “Trouble shooting” for more information.

8.2. Calibration – zeropoint

Note In most applications, zeropoint calibration is absolutely unnecessary and worse, can lead to problems with the measurement or the reference calibration. Zeropoint calibration is sensible only when a significant and constant zeropoint deviation is caused by water ingredients that do not react with the disinfectant.

Warning The zeropoint calibration can have dire consequences if done improperly! If, for example, a zeropoint deviation is due to substances that consume disinfectant and are through that process themselves consumed, it would be wrong to make a zeropoint calibration. Instead, the measurement has to be relocated to a point at which the consumption reaction is already complete!

> For zeropoint calibration supply the measuring point with disinfectant-free water that in every other respect and in all measuring conditions corresponds to your measuring water. Suitable is for example a measurement prior to disinfectant dosing. Removing disinfectant with chemicals on the other hand may change the water and the resulting zeropoint.

Note If you cannot measure disinfectant-free water but at least want to check the zeropoint, you can take a water sample at the measuring point and let it stand open for a while, preferably while stirring, until the disinfectant has evaporated. If you now stir the sensor in that sample, the measurement, while instable, will give you an idea on what value you would get as zeropoint. Do a zeropoint calibration only if the value deviates significantly from zero.

- > In the CAL menu, select ZEROPOINT.

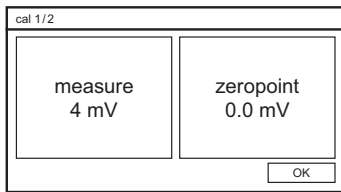

- > With OK you execute the calibration and reach the info screen, showing the results of the calibration.

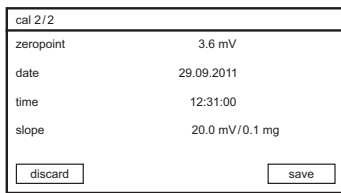

- > With the SAVE button you store the results. With DISCARD you reject the results and keep the previous calibration values.

Note After zeropoint calibration you have to carry out a reference calibration.

Note If following a zeropoint calibration you encounter difficulties with the measurement or the reference calibration, we strongly recommend to undo the zeropoint calibration by disconnecting the cable from the sensor and repeating the zeropoint calibration as soon as the measuring signal has dropped to 0mV.

8.3. Calibration – info

calibration	info	ESC
24.04.2012	14:08:56	20.0 mV 0.0 mV
21.04.2012	13:58:32	3.4 mV 0.0 mV
15.02.2012	14:24:38	8.9 mV 0.0 mV
08.01.2012	15:02:16	13.9 mV 0.0 mV
28.11.2011	13:30:01	20.2 mV 0.0 mV
21.09.2011	09:28:36	23.5 mV 0.0 mV

Select the symbol INFO in the CAL menu to view the last calibration results. This allows predictive maintenance.

In the example above, the slope decrease over time. On 24.4.12 the sensor was replaced.

9. Digital Inputs

9. Digital inputs

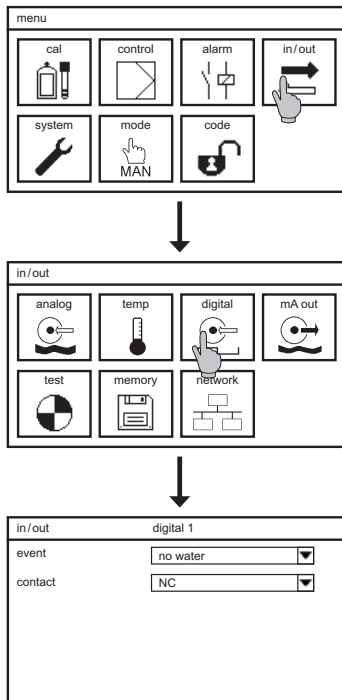

In the entry-level version, the Neon® instrument has one digital input. All settings concerning the digital input(s) are found in the submenu IN/OUT → DIGITAL. If you have two digital inputs, separate symbols will appear for them.

Contact

For both inputs you can define whether the input should work as a normally open (NO) or normally closed (NC) contact.

Event

You can select one of three text messages that will appear if the input is closed: low water, or level, or controller stop.

Note Switching of the digital input will stop the controller no matter what text you have selected.

Note If you have activated the add-on volume based Dosing, then the second digital input is used for the flow measurement. In that case no symbol for the second digital input appears.

10. Test menu

The menu TEST is only accessible in the MAN Mode. In all other modes, the symbol is not shown. The test menu always shows a list of the maximum available analog and digital outputs. Naturally, you can operate only those outputs that are activated in your instrument. In the entry-level version this means only relay 3.

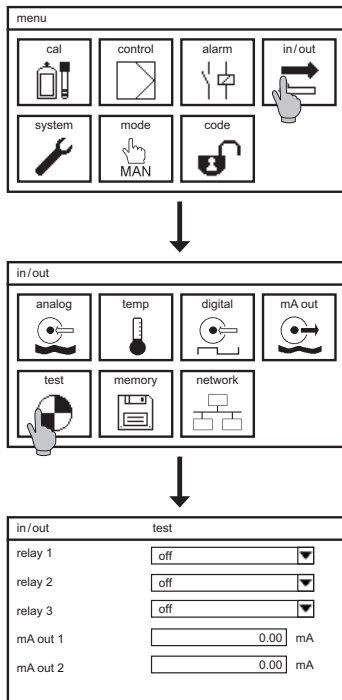

Set the mode to manual. Select the symbol TEST in the submenu IN/OUT.

In the submenu TEST you can switch all available relays and define mA values for the analog outputs. To switch a relay, select ON from its drop-down list.

To check an analog output, select its settings to open the keyboard. Set the output to a value between 0.00 and 22.00 mA. This value is then sent out via the selected analog output.

Note **When you leave the menu, all relays and all analog outputs are reset to their previous settings.**

11. Memory

11. Memory

In the menu MEMORY you can find all functions and settings concerning the SD card.

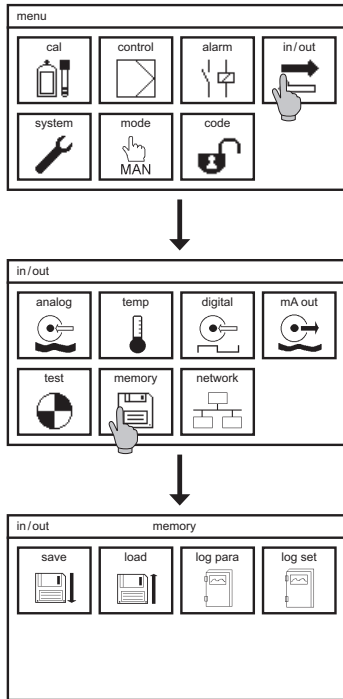

Select the symbol IN/OUT in the main menu, and then in the submenu the symbol MEMORY.

NOTE The submenus LOG PARA and LOG SET are shown only if the datalog function has been activated.

11.1. Store and upload settings

You can save all settings on the SD card, for safekeeping, or to duplicate the settings into another instrument of the same type. This way you can easily restore your settings with a new instrument, or after a software-update, or after adding additional functions. With an appropriate PC program, you can even do all settings on the PC and then load them into the Neon® instrument via SD card.

Note Settings can be duplicated only to instruments of the same type.

11.1.1. How to save settings

Make sure that an industry-standard SD card (max. 2 GB) with free storage space is plugged into the instrument.

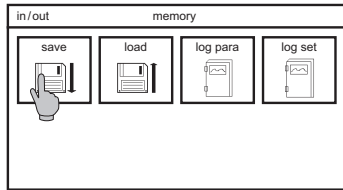

In the menu IN/OUT → MEMORY select the symbol SAVE.

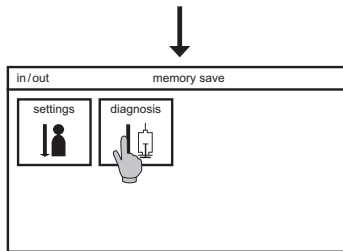

Select the symbol SETTINGS.

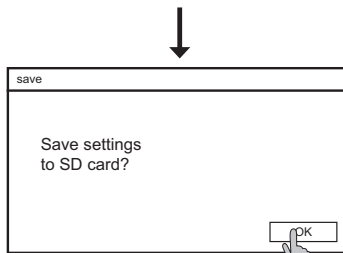

Acknowledge with OK.

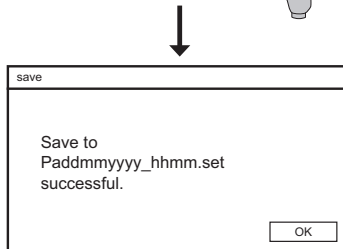

The display shows the name of the created file. The name consists of the parameter and the date. Acknowledge with OK.

11. Memory

11.1.2. How to load settings

Make sure that the SD card with the settings-file is plugged into the instrument.

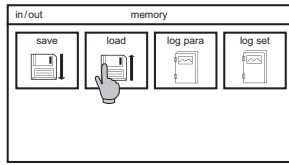

In the submenu MEMORY select the symbol LOAD.

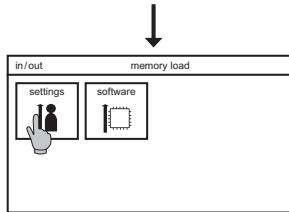

In the submenu select the symbol SETTINGS.

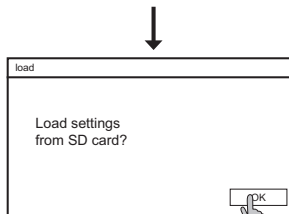

Acknowledge with OK.

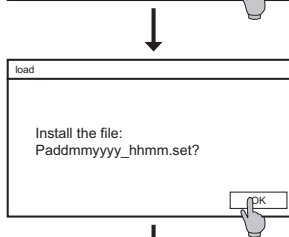

The display shows the name of the file that will be loaded. The name consists of the parameter and the date. Acknowledge with OK.

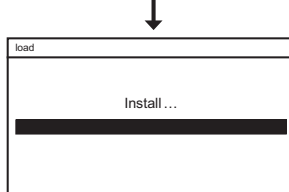

Progress is indicated by a status bar.

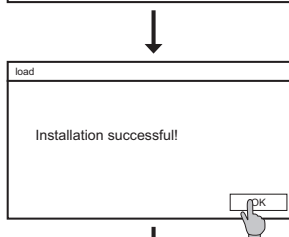

Acknowledge with OK.

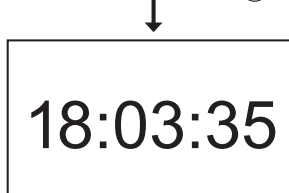

After installation, the instrument initializes. During that process, the time is displayed on the desktop.

Note You can only load settings files for the same parameter.

11.2. Software update

For a software-update we will send you two files. Save both files on an industry-standard SD card – directly, use no subfolder! Plug the SD card into the instrument.

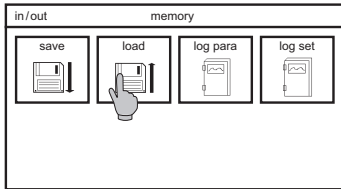

In the submenu MEMORY select the symbol LOAD.

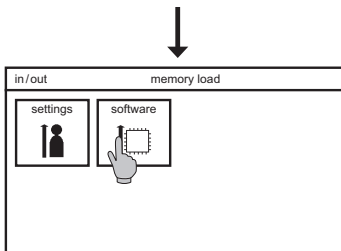

Select the symbol SOFTWARE.

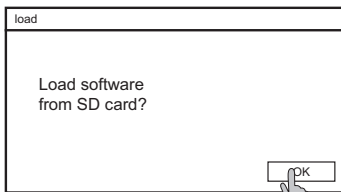

Acknowledge with OK.

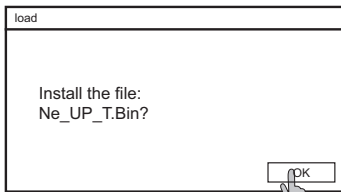

The display shows the name of the file that will be loaded. Acknowledge with OK.



Progress is indicated by a status bar.

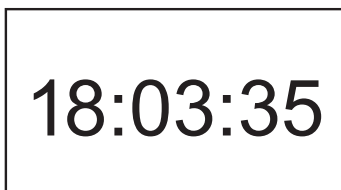

After installation, the instrument initializes. During that process, the time is displayed on the desktop.

11. Memory

11.3. How to save the diagnosis file

If the measurement does not run as planned, it is useful to assess the situation by checking all settings and current values. To collect all the information and maybe have it ready for a contact person, you can save a diagnosis file on the SD card.

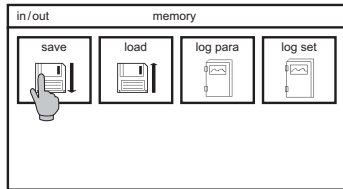

In the submenu MEMORY select the symbol SAVE.

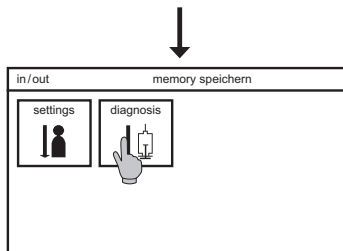

Select the symbol DIAGNOSIS.

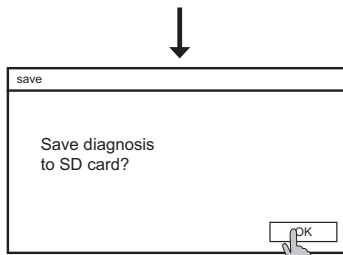

Acknowledge with OK.

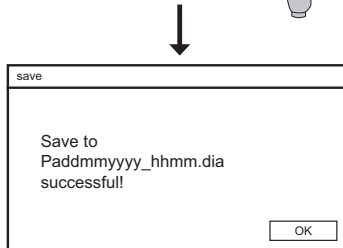

The display shows the name of the created file. The name consists of the parameter and the date. Acknowledge with OK.

Note The .dia file is a binary file and can only be read with an appropriate configuration program.

12. System functions

Note System settings can only be changed with the full access code.

12.1. Language

For the menu, a variety of languages are available. The entry-level version contains English and German.

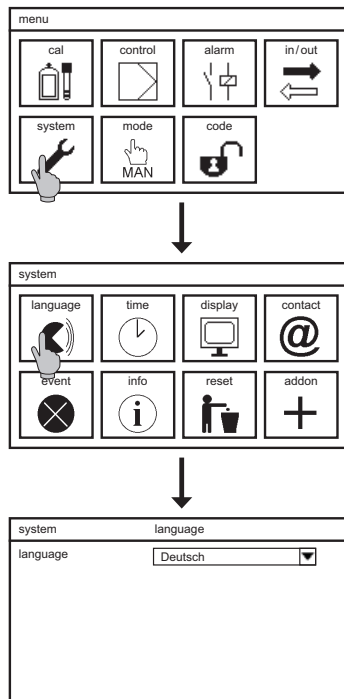

To change the language, select the symbol SYSTEM in the main menu and in the submenu the symbol LANGUAGE. A drop-down list shows all languages that are available on your instrument.

12.2. Time

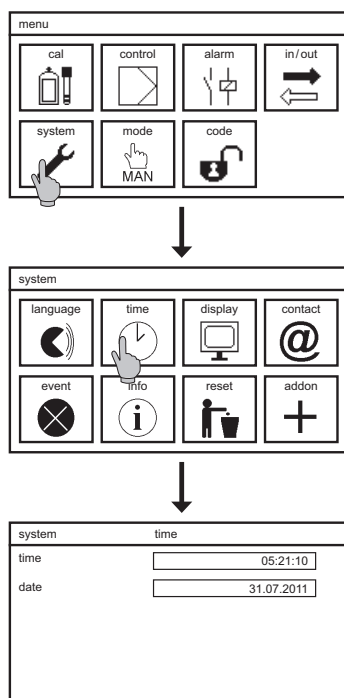

To set the internal clock, select the symbol SYSTEM in the main menu, and in the submenu the symbol TIME.

When you select the field of either time or date, a keyboard appears to enter the desired time or date. For your convenience, the instrument adds zeros automatically. If you enter 6, for example, the time will be set to 06:00:00.

Note If the batterie is missing or empty, the date shows 01.01.2012 after start-up.

12. System functions

12.3. Display

All settings concerning the display are found in the submenu SYSTEM → DISPLAY. The touch screen calibration is also found in this submenu.

12.3.1. Settings

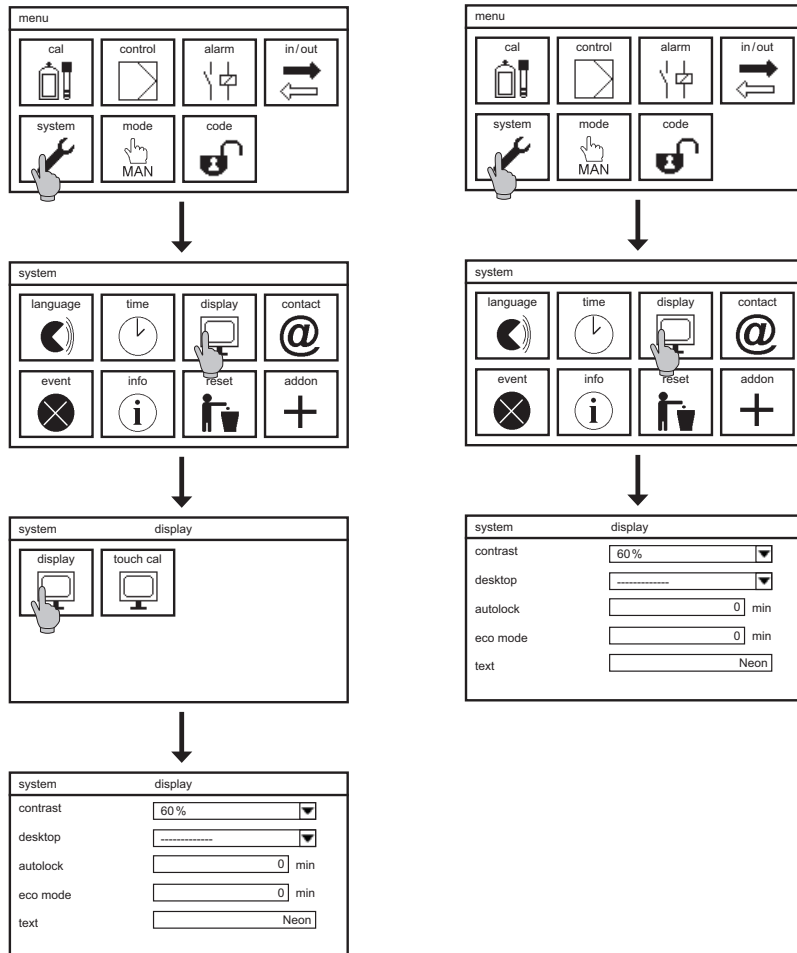

Contrast

With CONTRAST you can adjust the brightness of the display, between 0% and 100%.

Desktop

This submenu contains a drop-down list of various desktop designs. The selection is activated as soon as you leave the menu.

You can switch the display design by touching the instrument name on the desktop. To ensure that this selection is permanent, set the display design in the DESKTOP submenu to ----- . Otherwise the design will be reset to the one specified in this menu whenever you enter any menu.

Selection : -----

If you select the line (-----), the desktop remains in its previous design.

Note **Text, time, the triangle, and the event messages are part of all desktop designs.**

Selection: default

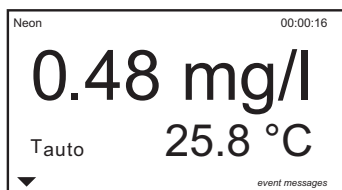

The default design shows the measured value and the temperature.

Selection: SD card

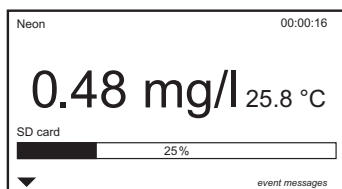

This adds a status bar indicating the remaining storage space on the SD card.

Selection: Contact

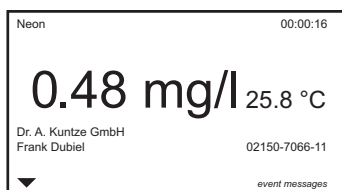

This adds the contact data that is stored in the submenu SYSTEM → CONTACT.

Selection: mA1 or mA2 (add-ons)

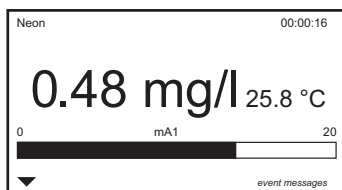

This adds an analog bar indicating the mA output of output 1 or 2, respectively.

Selection: S1 or S2 (add-on controller)

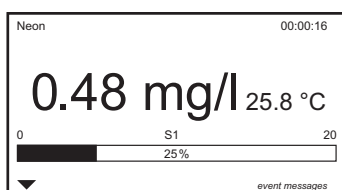

This adds an analog bar indicating the controller output for set point 1 or 2, respectively, in %.

12. System functions

Selection: Relays (add-on controller)

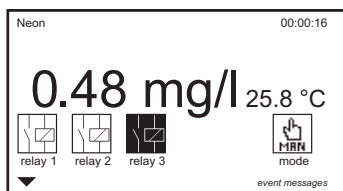

This adds the status of all three relays and the mode. Active relays are shown white on black, and the symbol shows whether the relay is open or closed. See relay 3 in the example shown.

Selection: Flow (add-on volume based dosing)

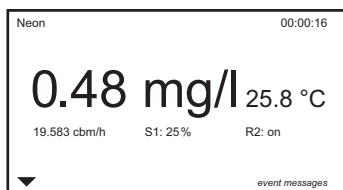

This adds the calculated flow rate, the controller output in %, and the status of relay 2.

Autolock

The autolock function ensures that an invalid code is set after an adjustable interval without operation, even if you have forgotten to change the code manually before leaving the instrument. Autolock sets the code back to 0000, and the display shows the desktop with the measured values. If you set the interval to 0, the autolock function is deactivated.

Eco mode

Eco mode turns off the display illumination after an adjustable interval. If you set the interval to 0, eco mode is deactivated, and the illumination remains on permanently.

Note **The eco mode not only saves energy, it also extends the life span of the display.**

Text

Here you can enter an identification or location, which will be shown on the left side of the top line of the desktop.

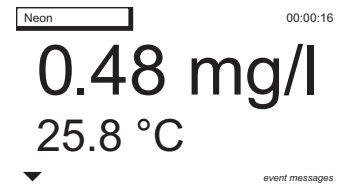

12.3.2. Touch Cal

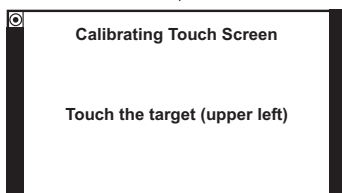
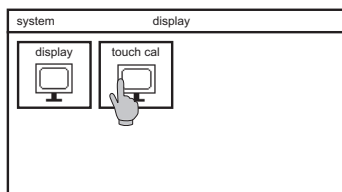
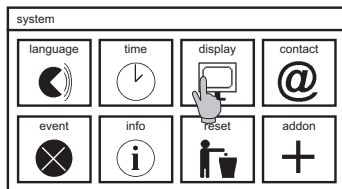
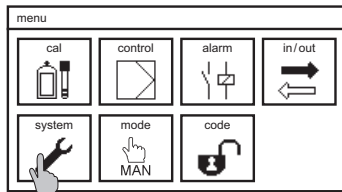

To calibrate the touch screen, select in submenu SYSTEM → DISPLAY the symbol TOUCH CAL to start the calibration. The touch screen calibration texts are available in English only.

Note When started, the calibration routine cannot be left until it is finished, it has to be carried out completely.

The routine comprises five steps. You have to touch each corner of the display, and finally the center of the displayed text.

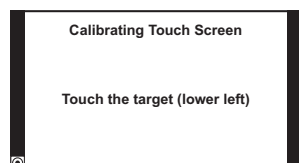
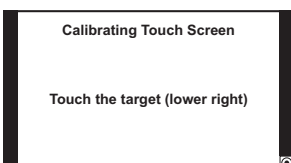
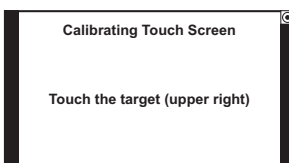
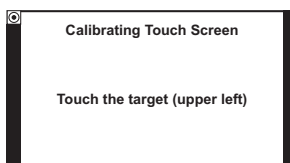

Note The touch screen calibration can also be started by touching the screen for more than 30 seconds.

12. System functions

12.4. Contact

In the submenu SYSTEM → CONTACT you can store contact data of your contact person, including company name, personal name, and phone number.

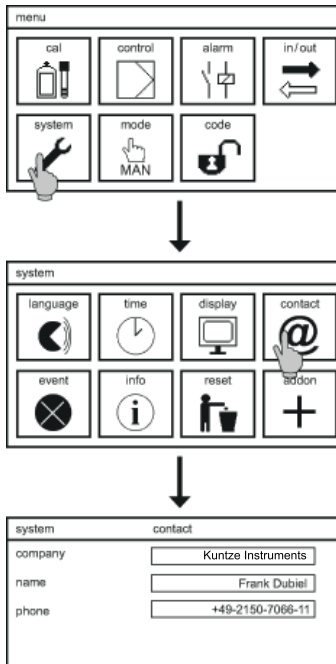

Select in the submenu SYSTEM the symbol CONTACT. For each field a keyboard opens to enter the name or number.

Note Contact data can be shown on the desktop, if you select the display design "Contact".

Note With restricted access (Code 0202) you can view this menu but not change the settings.

12.5. Event-related support

If an event message appears on the desktop, the submenu SYSTEM → EVENT provides information on the event and suggestions how to solve it.

Select in the submenu SYSTEM the symbol EVENT. With touch screen instruments you can reach this submenu directly by touching the event symbol on the desktop. If there are no event messages, the event help will only show “no active event”. If more than one event is currently indicated, you can scroll up and down to view all events.

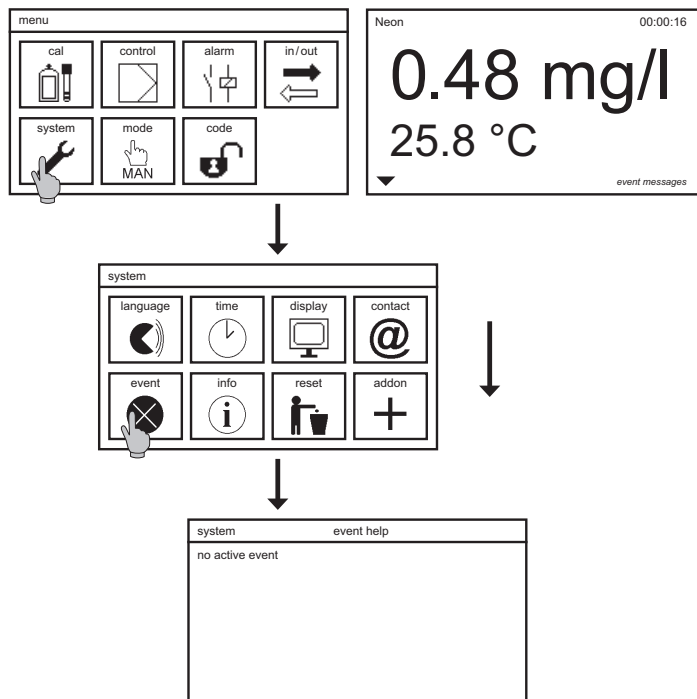

12. System functions

12.6. Info

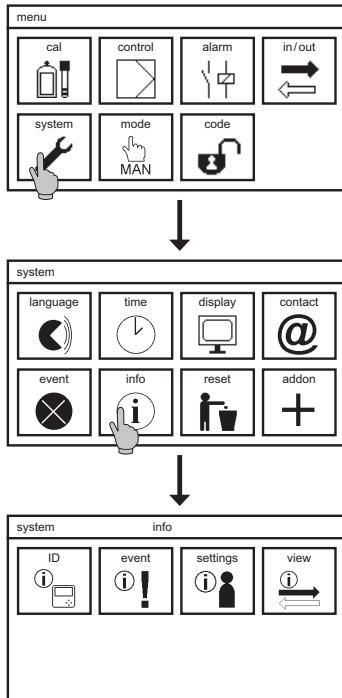

The submenu INFO is found in the submenu SYSTEM. It contains four symbols:

ID

This shows the serial number, the software version, and the operating hours of the instrument.

Eventlog

The event log stores up to 100 events, with the time they appear (*) or leave (#).

Settings

This submenu shows a complete list of all settings. Press UP and DOWN to view the complete list.

View

This submenu shows the raw signals of the sensors, the output signals of the mA outputs, and the status of the digital inputs.

Note **The analog outputs and the second digital output are add-ons, and are shown only if the instrument is equipped with these features.**

12.7. Reset to factory settings

The reset resets all settings to factory settings, measuring parameter, range, except the time, date, and contact. Activated add-ons will remain activated, of course.

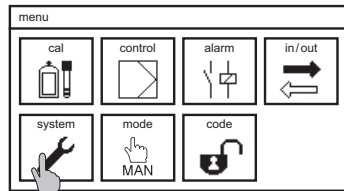

Select the symbol SYSTEM in the main menu, and in the submenu the symbol RESET.

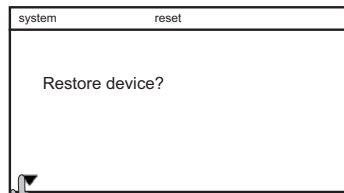
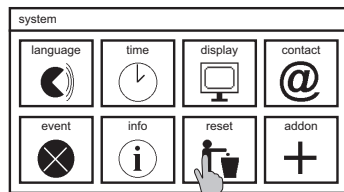

Go DOWN as indicated.

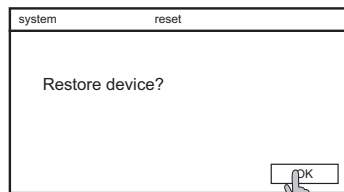

Acknowledge with OK.

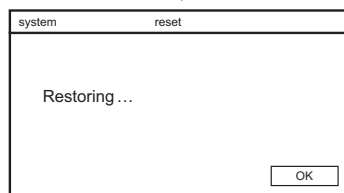

All settings are reset, and the instrument initializes.

Note With touch screen instruments, the touch screen has to be calibrated after reset. The calibration routine starts automatically.

12. System functions

12.8. Add-on activation

In this menu you can activate add-ons. Enter the 4-character code you have received with the purchase to add one or more of the following features:

- > Second digital input
- > Analog output
- > Second analog output
- > Data log
- > PID controller or volume based dosing
- > Modbus RTU (RS 485) – needs additional hardware
- > Automatic sensor cleaning ASR®

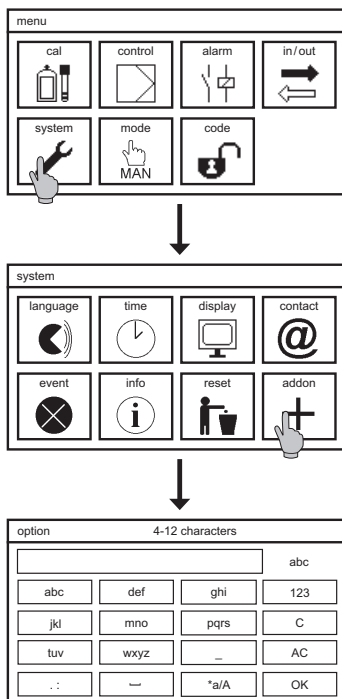

To activate add-ons, select the symbol SYSTEM in the main menu, and in the submenu the symbol ADD-ON.

A keyboard appears to enter the code.

Note The input is case-sensitive! Observe capital and small letters.

After a successful activation, the display shows which features have been activated, and the instrument initializes. If the entered code was incorrect, no message appears, and the previous settings are maintained.

Note We recommend to reset all settings to factory settings after activating add-ons.

13. Alarm relay

13.1. Settings

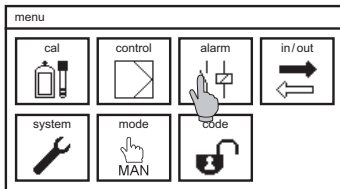

Select the symbol ALARM in the main menu.

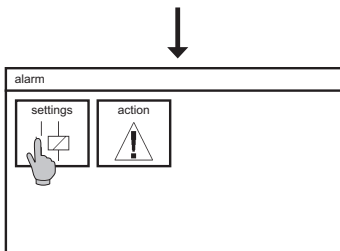

In the submenu, select the symbol SETTINGS.

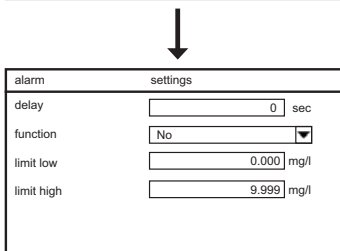

Here you can set the following parameters:

Delay

This defines a delay time – in case of an event, the alarm relay switches only after a specified interval. Display of the text message on the desktop and output of 22mA error current are not affected by this setting and will occur immediately.

Function

Here you can turn the normally open contact into a normally closed contact. That means that the relay is actively closed in case of normal operation and opens in case of alarm – with the advantage that power failure also leads to an alarm.

Lower limit/upper limit

You can define an upper and a lower limit. If the measured value is higher than the upper limit or lower than the lower limit, an alarm is issued via the alarm relay– if you have specified the limits as alarm actions.

13. Alarm relay

13.2. Alarm action

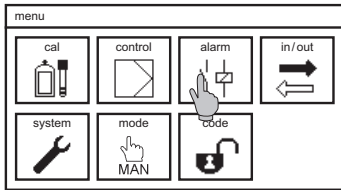

Select the symbol ALARM in the main menu.

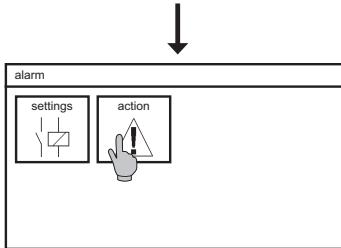

Select the symbol ACTION.

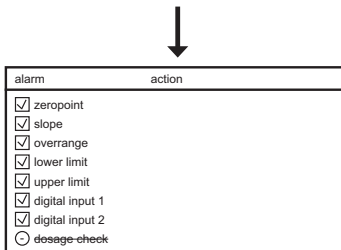

A list of all possible actions appears.

By activating the check boxes you can define actions as alarm actions. If a box is marked with a tick, the action or event will cause the alarm relay to switch. An empty box means that the action or event does not cause the alarm relay to switch. Overrange refers to both inputs, the message and alarm will occur if either input is affected.

Note If an action concerns an add-on that you have not activated, the box is crossed out and cannot be selected.

The following events always cause the alarm relay to switch:

- > Communication error
- > Unknown measuring module

14. Add-on Datalog

Note The symbols **DATALOG** and **STATUS** are shown only if the add-on datalog has been activated.

Note The Microsoft FAT (FAT16) file system root folder can manage a maximum of 512 entries. The use of long file names can significantly reduce this number of available entries. Always use an empty SD-Card or a SD-Card with limited entries in the root folder and an appropriate directory structure. Log files will be saved in a folder **LOG**.

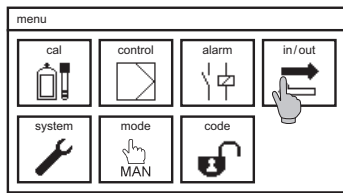

Select the symbol **IN/OUT** in the main menu, and in the submenu the symbol **MEMORY**.

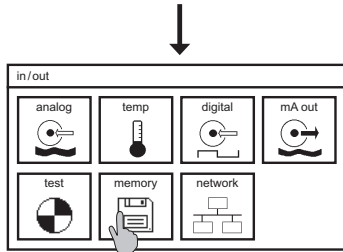

If the datalog add-on is activated, four symbols appear. In the menu **LOG PARA** you define which parameters you want to log. In **LOG SET** you define interval and log mode, and view the log status.

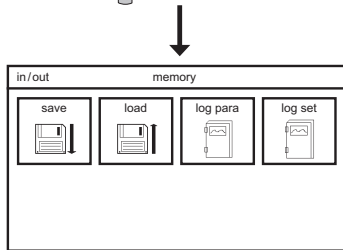

Log para

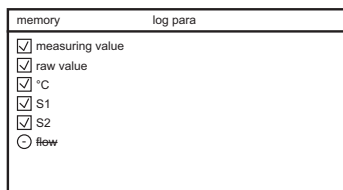

You decide which parameters are logged. Tick the boxes to log the parameter.

Log set

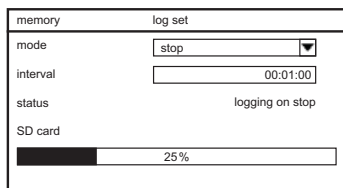

In the submenu **LOG SET** you can make the following settings:

14. Add-on Datalog

Mode

Start data logging by setting the mode to either stop or ring. Stop means that the logging stops when the card is full. Ring means that when the card is full, the oldest data will be overwritten.

Note **Never remove the SD card while the logging is running! Always set the mode to OFF (not stop!) before removing the card. Otherwise data loss might occur, and an error message will appear.**

Note **Always use a card with sufficient storage space, even with ring mode, otherwise the logging will not start.**

The INTERVAL defines the time between subsequent datalogs. You can enter an interval of 1 second up to 24 hours.

Example:

00:00:01 means that each second the values are logged.

00:01:00 means that each minute the values are logged.

01:00:00 means that once every hour the values are logged.

Note **The instrument fills in zeros automatically.**
Example: 1 is interpreted as 00:00:01 / 1: is interpreted as 00:01:00 / 1:1: is interpreted as 01:01:00

14.1. View logged data

To remove the SD card, first set mode to OFF, then press the SD card to take it out of the instrument.

Note If you remove the card without deactivating the logger, data loss might occur, and the instrument displays an error message.

```

1 Text:;Meom
2 Device SnNr:;Me00001301 ;
3 Device SW:;V 2.10 ;
4 Modul SnNr:;00103;
5 Modul SW:;V 02.00;
6
7
8 Mode: [Stop]
9
10 Interval: 1 sec
11
12
13 Date; Time; Measure-Value [pH]; mV-Value [mV]; Temperatur [°C];
14
15 14.09.2013;12:03:36;+6,99; +0; +25,0;
16 14.09.2013;12:03:37;+6,99; +0; +25,0;
17 14.09.2013;12:03:38;+6,99; +0; +25,0;
18 14.09.2013;12:03:39;+6,99; +0; +25,0;
19 14.09.2013;12:03:40;+6,99; +0; +25,0;
20 14.09.2013;12:03:41;+6,99; +0; +25,0;
21 14.09.2013;12:03:42;+6,99; +1; +25,0;
22 14.09.2013;12:03:43;+6,99; +1; +25,0;
23 14.09.2013;12:03:44;+6,99; +0; +25,0;
24 14.09.2013;12:03:45;+6,99; +0; +25,0;
25 14.09.2013;12:03:46;+6,99; +0; +25,0;
26 14.09.2013;12:03:47;+6,99; +0; +25,0;
27 14.09.2013;12:03:48;+6,99; +0; +25,0;
28 14.09.2013;12:03:49;+6,99; +0; +25,0;
29 14.09.2013;12:03:50;+6,99; +0; +25,0;
30 14.09.2013;12:03:51;+6,99; +0; +25,0;
31 14.09.2013;12:03:52;+6,99; +0; +25,0;
32 14.09.2013;12:03:53;+6,99; +0; +25,0;
33 14.09.2013;12:03:54;+6,99; +0; +25,0;
34 14.09.2013;12:03:55;+6,99; +0; +25,0;

```

Logged data are stored in CSV files. The file name consists of the measuring parameter, the date, and the time.

Each file starts with the device name, the instrument number, and the software versions, followed by the log mode and the interval. Measured values are listed line by line, separated by semicolons.

CSV files can be opened with commercially available spreadsheet software such as OpenOffice Calc or Microsoft Excel or in a simple text program.

For each day, a new file is created. Additionally, a new file is created if:

- > Power was turned off
- > The measuring parameter changed
- > The logging was stopped and restarted
- > Other parameters for the datalogging were selected

15. Add-on mA output

15. Add-on mA output

Up to two analog outputs are available as add-ons. As soon as at least one mA output has been activated, the symbol mA OUT appears in the submenu IN/OUT.

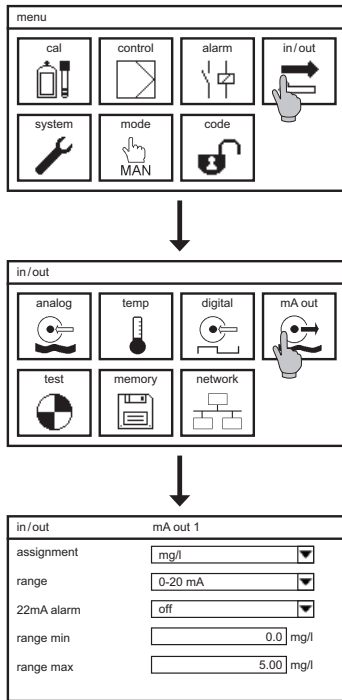

Select the symbol IN/OUT in the main menu and then select the symbol mA OUT. Here you can set the following parameters:

22 mA alarm

If you activate this function, the mA output rises to 22mA whenever the measuring inputs receive no proper signals.

Range

Select either 0-20mA or 4-20mA from the drop-down list.

Note

While 4-20mA gives slightly less resolution, it helps identifying cable breaks.

Assignment

Select which parameter you want to read out via the mA output: measured value, temperature, flow (volume based dosing) or controller output (controller).

Note

If the mA output is assigned to the controller there is not 22 mA alarm. By changing the assignment back to measured value the 22 mA alarm has to be activated again.

Range min and max

You can zoom by defining which measured values correspond to 0/4mA and which to 20mA. With these settings you can even invert the output, by assigning 20mA to a smaller value than 0/4mA. In case of controller output the output is in %, so you cannot set range min and max.

16. Add-on ASR®

Our patented Automatic sensor cleaning feature ASR® is available for Neon® instruments as add-on. When activated, the submenu ANALOG of the IN/OUT menu is complemented with the cleaning-related parameters.

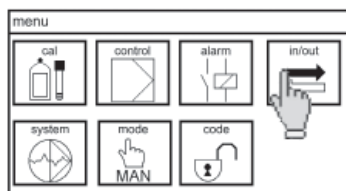

Select the symbol IN/OUT in the main menu, and in the submenu the symbol ANALOG. Subsequent to the usual parameters you find four more parameters that concern the cleaning function:

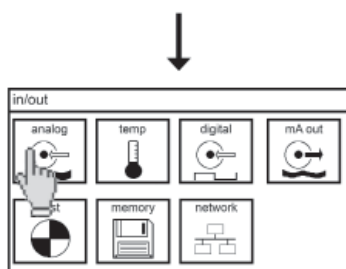

Base load

When activated, the instrument doses during cleaning with a constant controller output equal to the average of the last thirty minutes. Whenever this average is not available since the controller has not been running for 30 minutes after the last interrupt, cleaning is suspended.

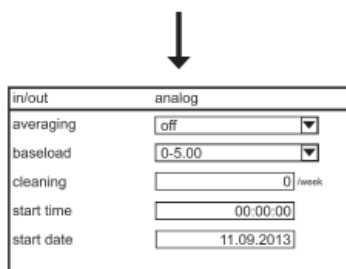

Warning

Base-load dosing is not monitored by measurement! Activate it only if no harm or damage can result!

Cleaning

Here you can activate and deactivate the cleaning and select an interval of 0-7 times per week.

Note For most applications, 1 cleaning cycle per week is ideal.

Note If you select 0/week, the cleaning function is deactivated.

Start time

Here you define at what time the first cleaning cycle starts. If possible, select a time at which there is no or constant dosing. After the first cleaning cycle, the display switches to the time of the next cleaning cycle.

16. Add-on ASR®

Start date

Define at what day the first cleaning is carried out. After the first cleaning cycle, the display switches to the date at which the next cleaning is scheduled.

Note **During the cleaning process, the measurement is switched off for a few minutes. The last measured value is frozen on the display and via the analog and digital outputs, and the controller is deactivated. In applications in which dosing stop cannot be tolerated, base-load dosing can be activated.**

Note **ASR® does not start if the event message “no water” or “check measuring input” is shown in the display or if you are currently in the calibration menu. The cleaning is delayed until the event message disappears or until you leave the calibration menu, respectively.**

17. Add-on Modbus RTU

Neon® instruments are optionally available with a serial interface RS 485 Modbus RTU. To use this function you have to install the RS 485 circuit-board, observing the ESD-directive, and activate the software with the appropriate add-on code obtained Kuntze Instruments.

When setting up a bus with several instruments, mind that the instruments are connected in line, not radially. Both ends of a long bus connection should be terminated with termination resistors of 120 Ohm. With Neon® instruments, you can activate the termination via menu.

Note **Activate the bus termination only at the ends of the line. If you activate terminations somewhere inbetween, this might cause malfunction in the bus communication.**

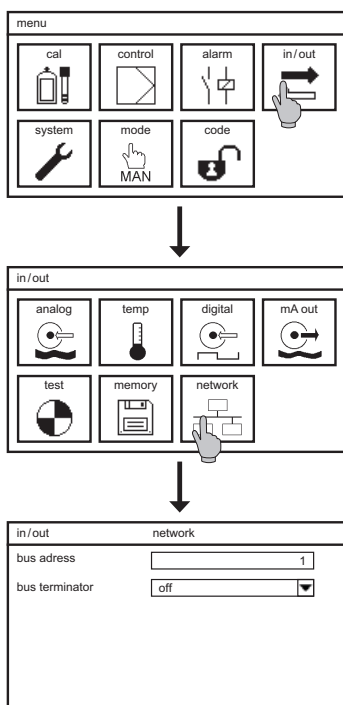

Select the symbol IN/OUT in the main menu and in the submenu, select the symbol NETWORK. Here you can set the following parameters:

Bus address

Assign a different number to each instrument in your bus system. With this number, you can address the instrument from the master instrument to read out data.

Bus termination

If you select in ON from the drop-down list, the termination is activated for this instrument.

17.1. How to read out data

Request

Function code	1 Byte	0x03
Start register	2 Bytes	0x0000 to 0xFFFF
Quantity of registers	2 Bytes	1 to 125 (0x7D)

17. Add-on Modbus RTU

Response

Function code	1 Byte	0x03
Bytes	1 Byte	2 x N*
Register value	N* x 2 Bytes	

*N = quantity of registers

Write single register

Function code	1 Byte	0x06
Register	2 Bytes	0x0000 to 0xFFFF

Write multiple registers

Function code	1 Byte	0x10
Start register	2 Bytes	0x0000 to 0xFFFF
Quantity of registers	2 Bytes	1 to 125 (0x7D)

17.2. Communication parameters

Baudrate:	19200 bps
Data bits:	8
Stopp- Bits:	1
Parity:	even
MODBUS address:	selectable between 1-31, factory settings: 1

17.3. Registers

Neon® provides the following variables:

- > Measured values: measuring parameter, temperature, and raw value
- > Controller outputs: S1 and S2 for add-on controller and S1 for add-on volume based dosing
- > Status of digital inputs and outputs: digital inputs 1 and 2, relays 1-3
- > Event messages
- > Calibration results as in the Cal/Info menu
- > Instrument data incl. activated add-ons

All parameter settings can be read and most parameters can be set via the interface.

All test functions can be activated via the interface.

17.3.1. How to read variables

Each variable has at least three registers. The first register contains the value, the second in the lower 8 bit the number of decimal places and in Bit 8 the percentage flag, which is set if a value is expressed as percentage of a given range. In that case, the value of the first register lies within 0 (0%) and 10000 (100%). The third register contains a code indicating a unit or text – refer to table “units and texts”.

Numerical values with a limited range have two additional registers specifying the minimum and maximum value of the range.

Example for a numerical value without percentage flag:

The temperature is listed as follows:

1. register: 4160, quantity of registers: 5

If you read these five registers, the response is as follows:

Reg. 1 (4136)	Reg. 2 (4137)	Reg. 3 (4138)	Reg. 4 (4139)	Reg. 5 (4140)
250d	1d	1001d	-300d	1400d
Value	Number of decimal places	Code of unit (°C)	Minimum of range	Maximum of range

The 1 in the second register means:

- > Value and range limits have to be divided by 10 to achieve one decimal place.
- > The percentage flag is not set. Otherwise the number in the second register would be 257 (=256+1; expressed as hexadecimal value 0101h). The value is not a percentage of the range but already the true measured value.

The first register gives the value 250. This represents a temperature of 25.0 and from the third register the unit °C.

Registers four and five show the range of the temperature measurement, which is -30.0...140.0°C.

*Example for a numerical value with percentage flag:
The lower limit is listed as follows:
1.register: 6304, quantity of registers: 5
If you read these five registers, the response is as follows:*

Reg. 1 (6304)	Reg. 2 (6305)	Reg. 3 (6306)	Reg. 4 (6307)	Reg. 5 (6308)
1111d (0457h)	258d (0102h)	1422d (058Eh)	65336d (FF38h)	1600 (0640h)
Value	Number of decimal places	Code of unit (pH)	Minimum of range	Maximum of range

The 258 in the second register means:

- > Percentage flag is set, the value is increased by 256 (expressed as hexadecimal value 0102h). The value is a percentage of the range. The true value has to be calculated from the range.
- > After deducting the 256, in the second register remains a 2. Measured value and range limits have to be divided by 100 to achieve two decimal places.

17. Add-on Modbus RTU

Registers 4 and 5 show the range of the lower limit, which is -2.00...16.00, and the third register shows the unit pH. The value of the first register is 1111, which is 11.11% of the range. Calculate $11.11 \times (18) / 100$ and you will find that the value is 2pH above the minimum of the range = pH 0.

Note **Text variables have 25 registers, each containing one character expressed in Ascii code. Text variables have no registers for decimal place, unit, or range.**

17.3.2. Measured values, controller outputs and status of digital inputs and outputs

For measured value and temperature, an additional HOLD-value is given out. The HOLD-Value equals the true value in the operation modes MAN and AUTO but is frozen whenever the instrument is set to HOLD. We recommend the use the HOLD-value if you have set alarm values in the PLC that you do not want to be activated during maintenance.

Note **The operation mode can be found in register 2240, refer to table “parameters”.**

Name	1. register	Quantity of registers	Type	Bytes
Measured value	4136	5	i_16	2
HOLD-value	4568	5	i_16	2
Temperature (Gas: measured value 2)	4160	5	i_16	2
HOLD-value of temperature (Gas: Hold-value measured value)	4584	5	i_16	2
Raw value Measuring input 1	4440	3	i_16	2
Raw value Measuring input 2	4648	3	i_16	2
Add-on controller: controller output S1	6848	5	i_16	2
Add-on controller: controller output S2	7128	5	i_16	2
Add-on volume based dosing: controller output S1	7296	5	i_16	2
Status digital input 1	6152	3	u_8	1
Status digital input 2	6184	3	u_8	1
Status relay 1 (controller)	6544	3	u_16	2
Status relay 2 (controller)	6568	3	u_16	2
Status relay 3 (alarm relay)	6592	3	u_16	2

17.3.3. Event messages and calibration results

Up to 100 event messages (current and logged) as well as the up to 10 logged calibration results of the Cal/Info menu are available via interface.

The index (registers 200 and 100) shows which entry is the first.

The time has three registers: Day+month contains the day in the upper 8 bits and the month in the lower 8 bits. Year+hour contains the year in the upper 8 bits and the hour in the lower 8 bits. Minute+second contains the minutes in the upper 8 bits and the seconds in the lower 8 bits.

For event messages, a code indicates the nature of the event – refer to table „event codes“.

Name	Register	Type	Bytes
Event log, index first entry	200	u_8	1
first entry day + month	201	u_16	2
first entry year + hour	202	u_16	2
first entry minute + second	203	u_16	2
first entry code (refer to the following table)	204	u_16	2
second entry day + month	205	u_16	2
...			
100. entry code	600	u_16	2
Calibration log, index first entry	100	u_8	1
first entry day + month	101	u_16	2
first entry year + hour	102	u_16	2
first entry minute+second	103	u_16	2
First entry slope	104	u_16	2
First entry zero-point	105	u_16	2
second entry day + month	106	u_16	2
...			
10. entry zero-point	150	u_16	2

17. Add-on Modbus RTU

Table event-codes

Code	Event
1, 2	Memory fault
5	Start
10, 11, 13, 14 - 18 and 45	Internal error
20	No communication with the measurement module
25	Unknown measurement module
30	Check measuring input
35	Check temperature input Gas: Check measuring input 2
40	Out of measuring range (below range)
41	Out of measuring range (above range)
49	Zero-point
50	Slope
51	Slope C-value invalid
52	TDS factor invalid
53	Check wiring of analog input 1
54	Sensor test failed measuring input 1 (GAS)
55	Sensor test failed measuring input 2 (GAS)
56	No sensor measuring input 1 (GAS)
57	No sensor measuring input 2 (GAS)
58	Wrong sensor measuring input 1 (GAS)
59	Wrong sensor measuring input 2 (GAS)
60	No SD card for saving
61	No SD card
62	SD card: write error
63	SD card: read error
65	SD card: invalid format
66	SD card: load error
70	SD card: logger stopped
82	Lower limit

Code	Event
83	M1 limit value 1 (GAS)
84	M1 limit value 2 (GAS)
85	Lower limit
86	M2 limit value 1 (GAS)
87	M2 limit value 2 (GAS)
90	Dosage check
92	Digital input 1 „no water“
93	Digital input 1 „level“
94	Digital input 1 „External Stopp“
95	Digital input 1 switched (GAS)
96	Digital input 2 „no water“
97	Digital input 2 „level“
98	Digital input 2 „External Stopp“
99	Digital input 2 switched (GAS)
105	Relay 3 (alarm relay)
115	mA 1 out of range
116	mA 2 out of range
118	Sensor test measuring input 1 (GAS)
119	Sensor test measuring input 2 (GAS)
120	Calibration
121	Start delay controller
122	Start delay cleaning
123	Cleaning
124	Cleaning – base load dosing

Note For events listed as „going“ in the eventlog, the numerical value is increased by 126.

17. Add-on Modbus RTU

17.3.4. Instrument data

Via the interface, all information on the instrument is available, including which add-ons are activated (read-only). Information on the measurement module and the add-ons are coded as 32-bit, refer to tables “Add-ons” and “Measurement module type”.

Name	Register	Quantity of registers	Type	Bytes
Serial number	1024	12	string	24
Hardware version	2464	4	u_32	4
Production date	2448	4	u_32	4
Activated add-ons	2128	4	u_32	4
Software version	1056	10	string	20
Operating hours	2080	4	u_32	4
Measurement module				
Type	2088	4	u_32	4
Serial number	4272	3	u_16	2
Software version	4280	3	u_16	2
Hardware version	4304	3	u_16	2

Table activated add-ons (register 2128)

The add-ons are coded as 32-Bit value as follows:

Bit number	Option
17	Add-on Second digital input
18	Add-on First analog output
19	Add-on Second analog output
20	Add-on Controller
21	Add-on volume based dosing
22	Add-on Modbus RTU
24	Add-on datalog
25	Add-on ASR®

Table measurement module type (register 2088)

The measurement module type is coded as 32-Bit value as follows:

Bit number	Option
10	Module pR
11	Module DIS
12	Module EC
13	Module EC IL
14	Module GAS
15	Module TCL

17.3.5. How to read and write parameter settings

Parameter registers are similar to the registers described above, but here you can change the settings via interface. Mind the ranges and the percentage-flag – if a variable is expressed as percentage of a range, a new value must also be expressed that way. Besides the percentage calculation, the range indicates what values are possible for a variable. Since the ranges can change according to settings or selections, the range has to be read prior to writing, to get the range, the percentage-flag setting, and the number of decimal places.

Text variables contain one character per register, in ASCII code. Mind the maximum text length.

Note **The parameters are listed in the order of their description in this manual, i.e. Code, Mode, IN/OUT, System, Alarm, and Add-ons. Mind that not all parameters listed are available in your instrument, according to settings and activated add-ons.**

Digital inputs	1. register	Quantity	Type	Bytes	Read/ write	range
Code	2096	8	u_32	4	no	yes
Operation mode	2240	3	u_8	1	yes	no
Settings for the measurement:						
Parameter: pR						
Buffer 1	4400	5	i_16	2	yes	yes
Buffer 2	4408	5	i_16	2	yes	yes
Internal buffer	4416	5	i_16	2	yes	yes
Connection	4336	3	u_16	2	yes	no

17. Add-on Modbus RTU

Digital inputs	1. register	Quantity	Type	Bytes	Read/ write	range
Measure	4552	3	u_8	1	yes	no
Averaging	4328	3	u_16	2	yes	no
Parameter: DIS						
Measure	4464	3	u_16	2	yes	no
Unit	4616	3	u_8	1	yes	no
Measuring range	4536	3	u_16	2	yes	no
Averaging	4328	3	u_16	2	yes	no
Cleaning	4624	5	u_8	1	yes	yes
Start time	4632	4	u_32	4	yes	no
Start date	4648	4	u_32	4	yes	no
Base-load	4640	3	u_8	1	yes	no
Parameter: EC (EC and EC IL)						
Measurement	4464	3	u_16	2	yes	no
Measuring range	4536	3	u_16	2	yes	no
Averaging	4328	3	u_16	2	yes	no
C-value	4664	5	u_16	2	yes	yes
TDS unit	4616	3	u_8	1	yes	no
TDS factor	4656	5	u_16	2	yes	yes
Parameter: TCL						
Measurement	1408	12	string	24	yes	no
Input signal	4680	3	u_8	1	yes	no
Measuring range	4536	3	u_16	2	yes	no
Unit	4616	3	u_8	1	yes	no
Parameter: GAS						
Measurement analog 1	4464	3	u_16	2	yes	no
Slope analog 1	4496	5	u_16	2	yes	yes
Sensor test analog 1	7544	5	i_16	2	yes	yes
Measurement analog 2	4688	3	u_16	2	yes	no
Slope analog 2	4504	5	u_16	2	yes	yes
Sensor test analog 2	7552	5	i_16	2	yes	yes

Digital inputs	1. register	Quantity	Type	Bytes	Read/ write	range
Temperature compensation						
Mode	4352	3	u_16	2	yes	no
Sensor type	4360	3	u_16	2	yes	no
Reference temperature	4376	5	u_16	2	yes	yes
Correction	4384	5	i_16	2	yes	yes
Manual value	4392	5	i_16	2	yes	yes
Temperature compensation	4672	3	u_16	2	yes	no
Temperature coefficient (DIS/EC/TCL)	4472	5	u_16	2	yes	yes
Digital inputs						
Dig. input 1 event	6176	3	u_8	1	yes	no
Dig. input 1 contact	6168	3	u_8	1	yes	no
Option: Add-on dig. input 2 event	6208	3	u_8	1	yes	no
Option: Add-on dig. input 2 contact	6200	3	u_8	1	yes	no
System						
Language	2200	3	u_8	1	yes	no
Time	0	2	u_32	4	yes	no
Displaycontrast	2208	3	u_8	1	yes	no
Desktop design	2216	3	u_8	1	yes	no
Autolock time	2224	5	u_8	1	yes	yes
Eco-mode time	2232	5	u_8	1	yes	yes
Text	1216	10	string	50	yes	no
Company	1120	12	string	50	yes	no
Name	1152	12	string	50	yes	no
Phone	1184	12	string	50	yes	no

17. Add-on Modbus RTU

Digital inputs	1. register	Quantity	Type	Bytes	Read/ write	range
Alarm						
Lower limit	6304	5	i_16	2	yes	yes
Upper limit	6312	5	i_16	2	yes	yes
GAS: M1 limit value 1	7560	5	i_16	2	yes	yes
GAS: M1 limit value 2	7568	5	i_16	2	yes	yes
GAS: M2 limit value 1	7576	5	i_16	2	yes	yes
GAS: M2 limit value 2	7584	5	i_16	2	yes	yes
Alarm relay function	6320	3	u_8	1	yes	no
Alarm delay	6328	5	u_16	2	yes	yes
GAS: delay relay 1	7520	5	u_16	2	yes	yes
GAS: delay relay 2	7528	5	u_16	2	yes	yes
GAS: delay relay 3	7512	5	u_16	2	yes	yes
Alarm action	6336	4	u_32	4	yes	no

The alarm action list (register 6336) is coded as 32 Bit-value as follows:

Bit number	Alarm action
0	Dig. input 1/GAS: sensor error
1	Dig. input 2/GAS: sensor error
4	Zeropoint
5	Slope
6	Overrange
8	Lower limit / GAS: limit value 1
9	Upper limit/GAS: limit value 2
12	Dosage check

Activated add-ons

Register 2128 indicates which add-ons are activated, as recently described.

Dependent on that, some or all of the following parameters are available:

Name	1. register	Quantity	Type	Bytes	Read/ write	Range
Add-on: datalog						
Interval	6488	8	u_32	4	yes	yes
Mode	6496	3	u_8	1	yes	no
Logparameter Meas. value/ Gas: measured value 1	6504	3	u_8	1	yes	no
Logparameter Temperature/ Gas: measured value 2	6512	3	u_8	1	yes	no
Logparameter Raw value	6520	3	u_8	1	yes	no
Logparameter S1	7456	3	u_8	1	yes	no
Logparameter S2	7464	3	u_8	1	yes	no
Logparameter Flow	7472	3	u_8	1	yes	no
Add-on: analog outputs						
mA1 22mA alarm	6368	3	u_8	1	yes	no
mA1 range	6376	3	u_8	1	yes	no
mA1 assignment	6384	3	u_8	1	yes	no
mA1 range min.	6392	5	i_16	2	yes	yes
mA1 range max.	6400	5	i_16	2	yes	yes
mA2 22mA alarm	6432	3	u_8	1	yes	no
mA2 range	6440	3	u_8	1	yes	no
mA2 assignment	6448	3	u_8	1	yes	no
mA2 range min.	6456	5	i_16	2	yes	yes
mA 2 range max.	6464	5	i_16	2	yes	yes
Add-on: Modbus RTU						
Bus address	6608	5	u_16	2	no	yes
Bus termination	6640	3	u_8	1	yes	no
Add-on: controller						
Start delay	6680	5	u_16	2	yes	yes
S1 control type	6704	3	u_8	1	yes	no
S1 direction R1	6712	3	u_8	1	yes	no

17. Add-on Modbus RTU

Name	1. register	Quantity	Type	Bytes	Read/ write	Range
S1 setpoint	pH: 6720 Redox: 7392 DIS/TCL/EC: 7488	5	i_16	2	yes	yes
S1 hysteresis	6728 Redox: 7424	5	i_16	2	yes	yes
S1 p-range	6736 Redox: 7440	5	i_16	2	yes	yes
S1 integral time	6744	5	i_16	2	yes	yes
S1 differential time	6752	5	i_16	2	yes	yes
S1 dosage check	6784	5	u_16	2	yes	yes
S1 pulse type	6864	3	u_8	1	yes	no
S1 pulse-frequency	6872	5	u_16	2	yes	yes
S1 pulse-pause	6880	5	u_16	2	yes	yes
S1 pulse min	6888	5	u_16	2	yes	yes
Rel. 1 on/off	6904	3	u_8	1	yes	no
S1 motor run time	6920	5	u_16	2	yes	yes
S2 control type	6984	3	u_8	1	yes	no
S2 direction R2	6992	3	u_8	1	yes	no
S2 setpoint	pH: 7000 Redox: 7400 DIS/TCL/EC: 7496	5	i_16	2	yes	yes
S2 hysteresis	7008 Redox: 7432	5	i_16	2	yes	yes
S2 p-range	7016 Redox: 7448	5	i_16	2	yes	yes
S2 integral time	7024	5	i_16	2	yes	yes
S2 differential time	7032	5	i_16	2	yes	yes
S2 dosage check	7064	5	u_16	2	yes	yes
S2 pulse type	7144	3	u_8	1	yes	no
S2 pulse-frequency	7152	5	u_16	2	yes	yes
S2 pulse-pause	7160	5	u_16	2	yes	yes

Name	1. register	Quantity	Type	Bytes	Read/ write	Range
S2 pulse min	7168	5	u_16	2	yes	yes
Rel. 2 on/off	7184	3	u_8	1	yes	no
Add-on: volume based dosing						
Dosage l/l (pR/EC)	7256 (higher bits) 7257 (lower bits)	8	i_32	4	yes	yes
Pulses	7264	5	u_16	2	yes	yes
Pump output	7280	5	u_16	2	yes	yes
Concentration (DIS/TCL)	7288	5	i_16	2	yes	yes
Setpoint (DIS/TCL)	7504	5	i_16	2	yes	yes
Circulation stop delay	7312	5	u_16	2	yes	yes
Pulse type	7320	3	u_8	1	yes	no
Pulse-frequency	7336	5	u_16	2	yes	yes
Pulse-pause	7344	5	u_16	2	yes	yes
Pulse min	7352	5	u_16	2	yes	yes
Rel. 1 on/off	6904	3	u_8	1	yes	no
Rel. 2 on/off	7184	3	u_8	1	yes	no

17.3.6. Units and texts

The following table contains the codes of the units and texts of register 3 of the variables:

Code	Unit
1001	°C
1054	s
1058	min
1059	h
1211	mA
1243	mV
1283	MOhm
1302	mS/cm

17. Add-on Modbus RTU

Code	Unit
1342	%
1353	l/h
1422	pH
1423	ppm
1552	µS/cm
1558	mg/l
1559	µg/l
1660	Times per week
1662	g/l
1663	cbm/h
1664	nA/ppm
1993	Pulses/h
1994	l/Pulse
1995	l/l
1996	– (no unit)
Text as enumeration, variable value determines which text applies, starting with 0:	
3001	NC/NO
3002	ON/OFF
3003	pH/mV
3004	Off/low/medium/high
3005	Coax/Triax
3006	PT100/PT1000
3007	Man/auto
3008	No water/level/ext. stopp GAS: relay 1, relay 2, relay 3, relay 1 and relay 2, all relays
3009	normal
3010	4-20 mA/0-20 mA
3011	20%/40%/60%/80%/100%
3012	----/default/SD card/contact/mA 1/mA 2/S1/S2/Relay/Flow
3013	Stop/Ring/OFF

Code	Unit
3014	ON/OFF/P/PI/PID/3point
3015	Pulse-pause/pulse-frequency
3016	Reduce/raise
3017	1 = 0-1000/2= 0-5/4= 0-10/8= 0-20/16 = 0-30
3018	µg/l / mg/l / ppm
3019	Chlorine/Chlorine dioxide/Ozone/Hydrogen Peroxide/Total Chlorine
3022	no sensor, Chlorine, Chlorine dioxide, Ozone
3023	0-20 mA, 4-20 mA, 0-2000 mV
from here bit mask	
3802	0-9.999 mg/l, 0-99.99 mg/l, 0-999.9 mg/l, 0-9.999 ppm, 0-99.99 ppm, 0-999.9 ppm, 0-99.99 NTU, 0-999.9 NTU
3803	-, -, -, 0-2.000 mS, 0-20.00 mS, 0-200.0 mS, 0-2000 mS, 0-9999 ppt, 0-9999 ppm, 0-9999 ppb
3804	0-2.000 µS, 0-20.00 µS, 0-200.0 µS, 0-2000 µS , 0-2.000 mS, 0-20.00 mS, 0-200.0 mS, 0-2000 mS, 0-9999 ppt, 0-9999 ppm, 0-9999 ppb

17.3.7. Test functions

To test the installation, you can operate all relays and current outputs manually, provided that these add-ons are activated in your instrument, and define relay status and current values via interface as in the test menu.

With register Test mode you switch the test mode on and off.

Name	1. register	Quantity	Type	Bytes	Read/ write	Range
Test mode	2152	3	u_8	1	yes	no
Relay 1	6552	3	u_16	2	yes	no
Relay 2	6576	3	u_16	2	yes	no
Relay 3	6600	3	u_16	2	yes	no
mA 1	6360	5	u_16	2	yes	yes
mA 2	6424	5	u_16	2	yes	yes

18. Add-on Controller

18. Add-on Controller

The add-on Controller offers a concentration-based controller with two independently configurable control relays. When you activate the add-on, the main menu shows an additional symbol CONTROL.

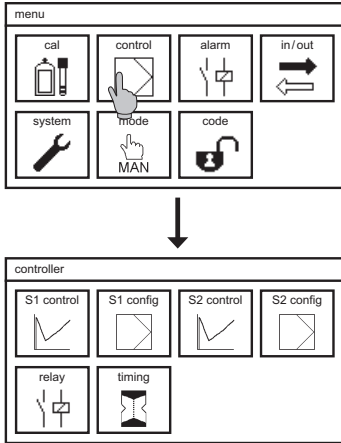

In the main menu select the symbol CONTROL. In the CONTROL menu you find the following submenus:

S1/S2 CONTROL, in which you can define the set point, the controller type, and its corresponding parameters.

S1/S2 CONFIG, in which you define the controller output via the relays, i.e. pulse-pause or pulse-frequency.

In the submenu RELAY you define the acting direction, i. e. whether dosing should happen when the measured value is above or below the set point. In this menu you can also turn off relays if you want to use the current outputs as controller output.

In the submenu TIMING you can define a start delay and dosage-check times.

18.1. S1/S2 control – set-point configuration

Note S1 refers to relay 1, S2 to relay 2.

Note Although the description always refers to S1, the procedure for S2 is the same.

Note If S1 was configured as 3-point controller, S2 cannot be used.

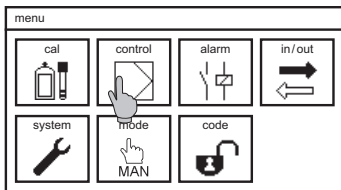

In the menu CONTROL select the symbol S1 CONTROL. Here you can set the following parameters:

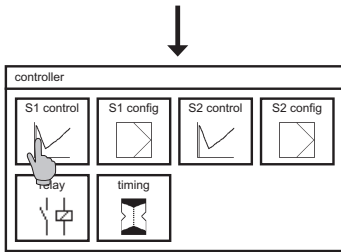

Set point

Define which value the measured value should reach.

Type

Choose between on/off, P, PI, PID, and 3-point controller. This selection defines the parameters displayed in this menu and in CONFIG. Only those parameters relevant for the selected controller are shown.

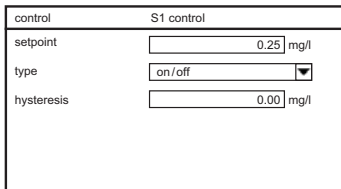

Note To help you with the configuration, Neon® only shows those parameters relevant for your controller choice. Same for the CONFIG menu which shows only the required information.

18.1.1. ON/OFF controller

The ON/OFF controller doses with 100% until the measured value reaches the set point, and then stops.

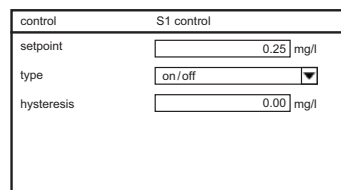

Besides set point and controller type you can set the following parameter:

Hysteresis

For the on/off controller you can define a hysteresis. This prevents constant switching of the relays in the vicinity of the set point – the relay switches only when the difference between set point and measured value exceeds half the hysteresis value.

18. Add-on Controller

18.1.2. P controller

The P controller reduces the dosing when the difference between set point and measured value is smaller than the specified P range. Within the p range, the controller output is proportional to the remaining deviation. When the measured value reaches the set point, dosing stops.

control		S1 control	
setpoint	<input type="text" value="0.25"/>	mg/l	
type	<input type="text" value="P"/>	▼	
P range	<input type="text" value="0.00"/>	mg/l	

Besides set point and controller type you can set the following parameters:

P range

The P range or proportional range is the range in which dosing is reduced proportional to the deviation between set point and measured value. The bigger the P range, the softer the control.

To find the ideal setting, start with a big P range and reduce it until the measured value oscillates around the set point in a stable manner. Double this value to get the ideal value. If the measured value still oscillates, use a slightly higher value.

18.1.3. PI controller

The PI controller is a P controller with additional I function. The I function sums up the previous dosing, so that the controller output drops to zero only after the measured value already exceeds the set point. This eliminates in applications with constant inflow the otherwise unavoidable control deviation.

control		S1 control	
setpoint	<input type="text" value="0.25"/>	mg/l	
type	<input type="text" value="PI"/>	▼	
P range	<input type="text" value="0.00"/>	mg/l	
integral time	<input type="text" value="0.00"/>	sec	

Besides set point and controller type you can set the following parameters:

P range

For settings and information refer to P controller.

Integral time

The shorter the integral time, the stronger the I function.

Start by setting a P controller, then reduce the proportional range until the measured value fluctuates constantly around the set point. Measure the time between subsequent maximum measured values. The ideal P range is then 2.2 times the current setting and the ideal integral time is 0.85 times the measured time between maximum values. If the measured value still oscillates set slightly higher values.

18.1.4. PID controller

The PID controller is a PI controller with additional D function. The D function acts swifter and compensates the inertia of the I function. This allows the controller to react faster to large control deviations.

control		S1 control	
setpoint	<input type="text" value="0.25"/>	mg/l	
type	<input type="text" value="PID"/>		▼
P range	<input type="text" value="0.00"/>	mg/l	
integral time	<input type="text" value="0.00"/>	sec	
differential time	<input type="text" value="0.00"/>	sec	

Besides set point and controller type you can set the following parameters:

P range

For settings and information refer to P controller.

Integral time

For settings and information refer to PI controller.

Differential time

The higher the differential time, the stronger the D function.

Start by setting a P controller, then reduce the proportional range until the measured value fluctuates constantly around the set point. Measure the time between subsequent maximum measured values. The ideal P range is then 1.66 times the current setting, the ideal integral time is 0.5 times and the ideal differential time 0.12 times the measured time between maximum values. If the measured value still oscillates set slightly higher values for P and I and slightly lower values for D.

18.1.5. 3-point controller

Note Set point S2 cannot be used when S1 is configured as 3-point controller.

Note Relay 1 is assigned to OPEN and relay 2 to CLOSE.

The 3-point controller is used for actuators that have not only two states (ON and OFF) but three: OPEN, OFF, and CLOSE, such as motor-operated valves.

control		S1 control	
setpoint	<input type="text" value="0.25"/>	mg/l	
type	<input type="text" value="3 point"/>		▼
P range	<input type="text" value="0.00"/>	mg/l	
integral time	<input type="text" value="0.00"/>	sec	
differential time	<input type="text" value="0.00"/>	sec	

Besides set point and controller type you can set the following parameters:

P range, integral time and differential time

3-point controllers can be configured as PI or PID controller. Settings are the same as described above. If you set the differential time to zero, the controller type is PI.

Hysteresis

For 3-point controllers you can define a hysteresis to prevent constant movement of the actuator in the vicinity of the set point. The relay switches only when the difference between set point and measured value exceeds half the hysteresis value.

18. Add-on Controller

18.2. S1/S2 CONFIG – configuring the controller output

Note In this menu you define the controller output via relays. If you want to use an analog output as controller output, you can ignore the CONFIG menu. Instead, you have to assign the analog output to control variable S1 or S2 in the menu IN/OUT-> mA OUT. In that case you can shut off the relay completely in the menu CONTROL->RELAYS.

In the menu CONTROL select the symbol S1 CONFIG. Depending on your choice of controller type, the CONFIG menu shows parameters for P /PI /PID or 3-point controller.

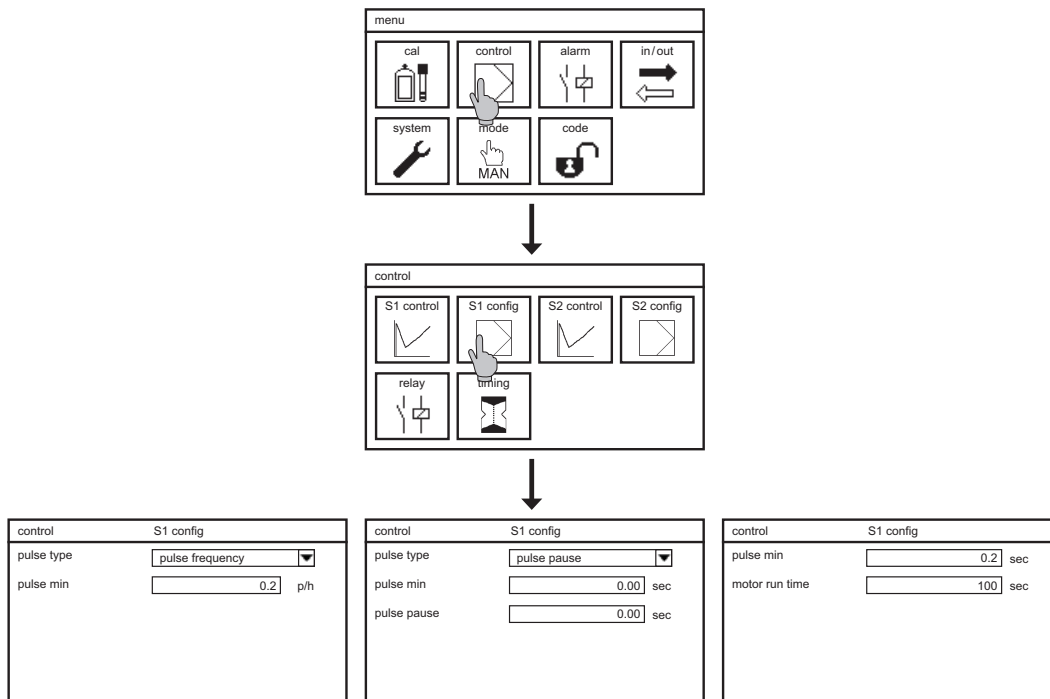

Note To help you with the configuration, Neon® only shows those parameters relevant for your controller choice.

Note If you have selected an ON/OFF controller, no configuration is required, and you cannot access the CONFIG menu.

18.2.1. CONFIG – pulse-pause or pulse-frequency for P/PI/PID

Select the controller type P or PI or PID in the menu S1/S2 CONTROL. Enter the menu S1/S2 CONFIG and set the following parameters:

Pulse type

When using the relays to control actuators, proportional reduction can be achieved in two ways: via time frames in which the relay is on (pulse) and off (pause) in relation to the controller output (pulse-pause controller) or via the switching frequency of the relay (pulse-frequency controller).

Pulse min (only for pulse type = pulse pause)

Define a minimum pulse, i.e. the minimum time the relay has to be on to allow the actuator to react.

Pulse pause (only for pulse type = pulse pause)

For a pulse-pause controller define as Pulse-Pause time a time-frame in which the relay is on (pulse) and off (pause) according to the control variable.

Note **The pulse-pause time must be at least twice as long as the minimum pulse.**

Pulse frequency (only for pulse type= pulse frequency)

Enter the frequency that corresponds to maximum dosing.

18.2.2. CONFIG – Motor run time and minimum pulse for 3-point controller

Select the controller type 3-point controller in the menu S1 CONTROL. Enter the menu S1/S2 CONFIG and set the following parameters:

Pulse min

Define a minimum pulse, i. e. how long the relay has to be ON to allow the actuator to react.

Motor run time

To control a motor-operated valve, the instrument needs to know how long it takes the motor to completely open the valve when it had been completely closed.

Determine that time by closing the valve completely and then opening it in manual operation, or vice versa. This time is the motor run time.

18. Add-on Controller

18.3. Configuration of the relays

control	relay
R1 direction	raise
R1 on/off	on
R2 direction	reduce
R2 on/off	on

In the menu CONTROL select the symbol RELAYS. In the submenu you can define the following parameters:

R1/R2 direction

With this setting you define whether dosing occurs above or below the set point.

Select RAISE if the dosing increases the measured value. The controller doses whenever the measured value is lower than the set point.

Select REDUCE if the dosing decreases the measured value. The controller doses whenever the measured value is higher than the set point.

R1/R2 on/off

You can shut off the relays completely to prevent unnecessary wear and tear. This is useful if you use the analog outputs as controller output.

18.4. Start delay and dosage control

menu			
cal	control	alarm	in/out
system	mode	code	



control			
S1 control	S1 config	S2 control	S2 config
relay	timing		



control	timing
delay	20 sec
S1 dosage check	0 min
S2 dosage check	0 min

Select CONTROL in the main menu, and in the control menu the symbol TIMING. In this you can define three important times for the controller:

Delay

The delay is the time that has to pass after a controller stop before dosing starts. A controller stop happens when the power is cut off or as a result of certain events, for example the switching of a digital input. At the end of this chapter you will find a list of these events.

Note

Changing the operation mode does not activate the start delay.

Dosage check

With the parameter dosage check you define how long the instrument may dose with 100% feed rate without raising alarm. If after that time the measured value still has not reached the set point or at least the P range, so that the controller output is still 100%, an alarm is issued and the controller is stopped. This is a safety measure to prevent the release of hazardous chemicals in case of damaged feed lines – if the dosing does not seem to have any effect, the reason might be that there is a leak somewhere and the chemicals do not reach the water.

NOTE **Dosage check alarm stops only the corresponding controller/set point. The other remains active.**

NOTE **If you set the time to 0 min, the function is deactivated for the corresponding controller.**

18.5. Activating and deactivating the controller

To activate or deactivate the controller you have to change the operation mode. You can change the mode in the main menu by pressing the symbol MODE. The symbol changes its design according to the selected mode.

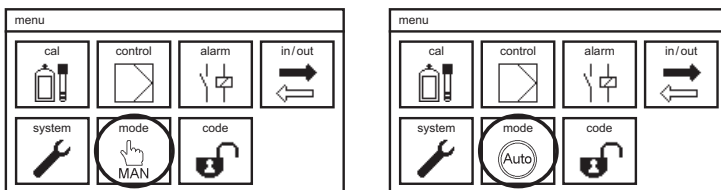

In the AUTO mode the controller is active and operates the relays and/or current outputs and ultimately the connected actuators. Manual operation of the relays and current outputs via the test function is not possible.

In the manual mode (MAN) the controller is deactivated and you can operate the relays and current outputs manually via the test function.

In the maintenance mode – HOLD - the controller is deactivated.

NOTE **More information on the operation modes can be found in chapter 5 – Mode.**

18.6. Relay display and manual operation of the control relays

For control applications, we advise to use the desktop design “Relay” in the menu SYSTEM.

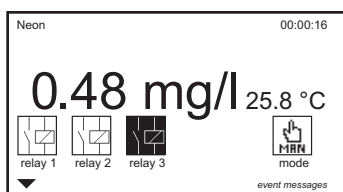

Below the measured values the configuration and status of the relays are displayed, and a button appears with which you can change the operation mode.

Note **More information on the various display designs can be found in chapter 12 – system functions.**

In the manual mode you can operate the relays manually. With touch screen instruments press the symbol of a relay to switch it. With instruments with key operation press key up until the desired relay is highlighted, then switch the relay with the OK key.

18. Add-on Controller

Warning **Manually activated relays remain activated until they are manually switched off or the operation mode is set to automatic!**

18.7. Automatic controller stop

The instrument provides various safety measures to recognize problems and to stop the dosing if no reliable measured values are available. Such situation occurs in case of the following events:

- > If the measuring input or the temperature input receives no signal (no measured value available)
- > If a digital input switches (no water, no reagent, or external controller stop)
- > Dosage check (possible damage on the feed lines)

It is your responsibility to ensure through set-up and settings that all these safety features can work as planned and to check their proper function through regular tests! Also use the safety features that are not controller-related, such as the alarm relay, the limits, and the 22mA alarm current.

WARNING **In the AUTO mode the controller actuates the dosing of possibly hazardous chemicals! Check all connections, feed lines, and all settings before you activate the controller, and make sure that the control works properly before leaving the instrument!**

19. Add-on volume based dosing

The add-on volume based dosing offers a control version that is based on the volume and flow rate of the water that is to be treated. Relay 1 is used to operate the dosing pump. With relay 2 you can operate the circulation pump that provides water for the concentration measurement.

Note It needs a flow meter that turns the flow rate into digital pulses, connected to the digital input 2. (NPN, max 180 Hz)

If you have added the add-on, the main menu shows the symbol DOSAGE.

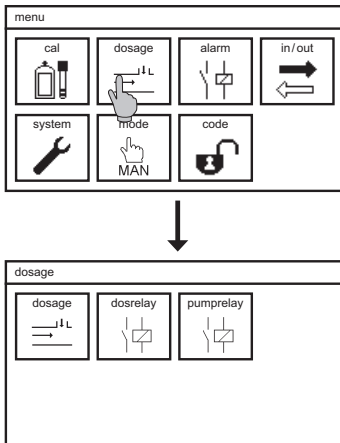

In the menu DOSAGE you will find the following submenus:

DOSAGE, where you define all parameters necessary to calculate the flow and the dosing volume.

DOSRELAY, where you define the output as pulse-pause or pulse-frequency.

PUMP RELAY, where you define parameters for your circulation pump.

19.1. Dosing parameters

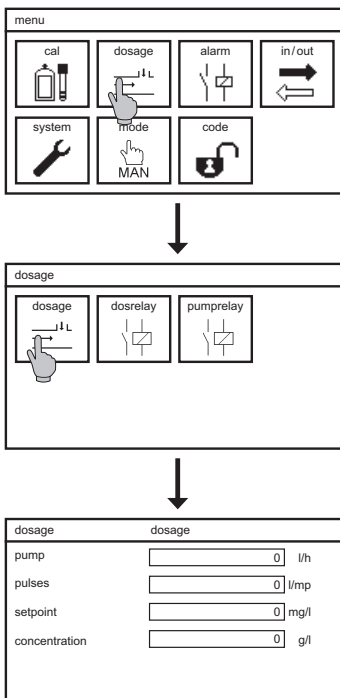

In the DOSAGE menu select the symbol DOSAGE. Here you have to set the following parameters:

Pump output

Define how many liters per hour the pump feeds.

Pulses

Define how many pulses the flow meter gives per liter. This information allows the instrument to calculate and display the flow rate.

19. Add-on volume based dosing

Set point

With the set point you define the concentration value you want to realise in the water through dosing.

Concentration

Enter the concentration of the reagent that is dosed. From these settings the instrument calculates how much reagent per liter has to be dosed.

19.2. Configuration of the dosing relay

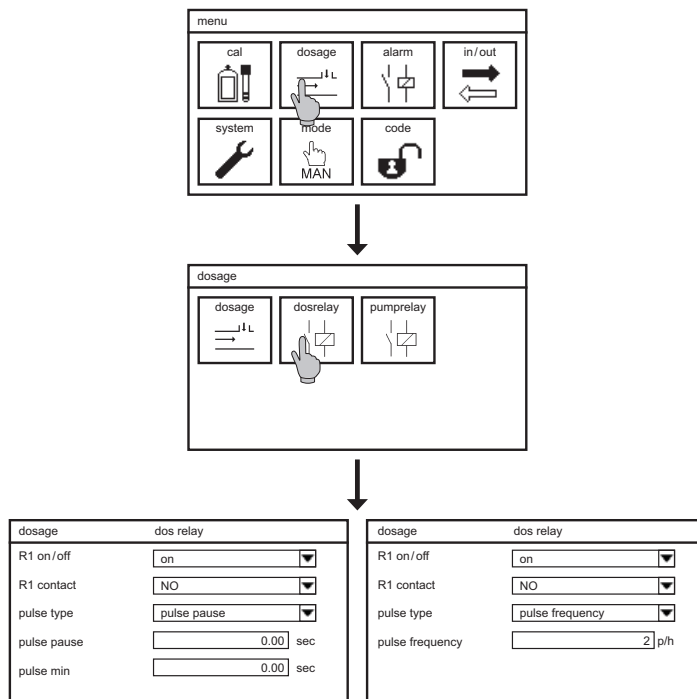

In the DOSAGE menu select the symbol DOSRELAY.

R1 on/off

If you do not want to use the relay as controller output, you can switch it off completely.

Relay 1 contact

Relay 1 is a normally open contact. In the menu you can invert it so that it is actively closed. If you select NC (normally closed contact) the relay will open to dose and close to pause.

Note To use an analog output as controller output you have to enter the mA menu in the IN/OUT menu and assign the mA output to control variable S1 or S2, respectively – see chapter analogue output.

Warning If you invert the relay you must take precautions that the dosing is stopped in case of power interrupt! If the instrument does not get power, the relay will open, sending dosing pulses to the pump!

Pulse type

The controller output via the relay can be realized in two ways: via time frames in which the relay is part-time on and off (pulse-sequence type), or via the switching frequency (pulse-frequency type).

Pulse min (only for pulse type = pulse pause)

Define a minimum pulse, i.e. the minimum time the relay has to be on to allow the actuator to react.

Pulse pause (only for pulse type = pulse pause)

For a pulse-pause controller define as Pulse-Pause time a time-frame in which the relay is on (pulse) and off (pause) according to the control variable.

Note **The pulse-pause time must be at least twice as long as the minimum pulse.**

Pulse frequency (only for pulse type= pulse frequency)

Enter the frequency that corresponds to maximum dosing.

19.3. Pump relay

In applications with volume based dosing, the measuring point is usually installed in a bypass, and measuring water is supplied by a circulation pump. Via the pump relay you can switch off the pump if no water is available in the main pipe.

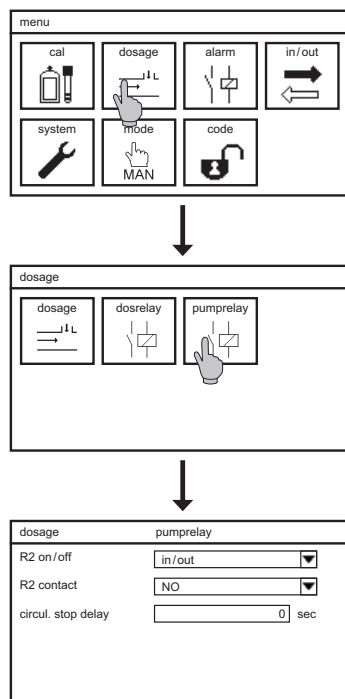

In the menu DOSAGE select the symbol PUMP RELAY.

R2 on/off

If you do not want to control the circulation pump with the relay, you can switch it off.

Relay 2 contact

Relay 2 is a normally open contact. In the menu you can invert it so that it is actively closed. If you select NC (normally closed contact) the relay will open to activate the pump and close to stop it.

Attention

If you invert the relay and the instrument does not get power, the relay will open, turning on the pump regardless of the water situation! In that case you have to take other precautions that the pump cannot run dry.

Circulation stop delay

Here you can define how long the circulation pump should keep on running after the flow meter has indicated that the flow has stopped.

19. Add-on volume based dosing

19.4. Activating and deactivating the dosing

To activate or deactivate the dosing you have to change the operation mode.

You can change the mode in the main menu by selecting the symbol MODE. The symbol changes its design according to the selected mode.

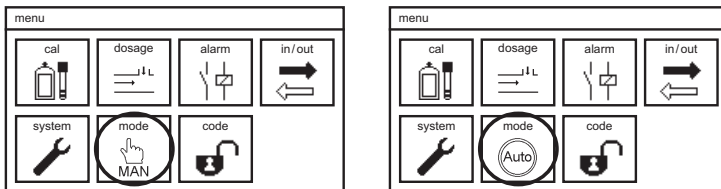

In the AUTO mode the controller is active and operates the relays and/or current outputs and ultimately the connected actuators. Manual operation of the relays and current outputs via the test function is not possible.

In the manual mode (MAN) the controller is deactivated and you can operate the relays and current outputs manually via the test function.

In the maintenance mode – HOLD - the controller is deactivated.

NOTE More information on the operation modes can be found in chapter 5 – Mode.

19.5. Flow display

For applications with volume based dosing, we advise to use the desktop design “Flow” in the menu SYSTEM.

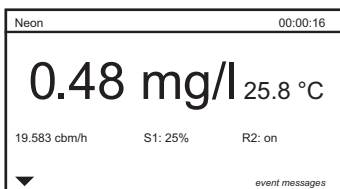

Below the measured values the flow rate, the controller output in % and the status of relay 2 are displayed.

Note More information on the various display designs can be found in chapter 12 – system functions.

19.6. Automatic dosage stop

Since the control is based on the flow measurement, the concentration measurement and the temperature measurement have no influence on the controller.

Warning In the AUTO mode the controller actuates the dosing of possibly hazardous chemicals! Check all connections, feed lines, and all settings before you activate the controller, and make sure that the control works properly before leaving the instrument!

Use all safety measures that the instrument provides, such as the alarm relay, the limits, the 22mA alarm current etc. We advise to take precautions that measurement-related events and limit alarms also lead to a dosing stop.

20. Operation and Maintenance of Neon® DIS and Krypton® DIS

20.1. Start-up

Before turning on the water flow, make sure that the sensor is installed, that the cock of the sampling point is closed and the cock of the outlet is open, that all measuring and operation conditions are met and that all connections are sealed tight and pressure-proof.

Turn on the power. The instrument starts with a self-check and displays first the time and then the measured values. If no water is running through the assembly, the message “no water” or “ext. controller stop” is displayed, according to settings.

Check the settings of parameter and measuring range in the menu IN/OUT->analog. If these settings do not match your requirements, change them now – changing the parameter leads to a repolarisation of the sensor and prolongs the polarization time.

Open the inlet cock until water runs through the assembly and the message disappears. Wait a few minutes until the complete system is filled with water and both the disinfection measurement and the temperature measurement have stabilized. Carry out the settings for the temperature compensation before you calibrate the disinfection measurement. The Total Chlorine measurement will take longer to stabilise. It might require recalibration after the first 24h.

For calibration the sensor has to remain installed. Take a sample of the measuring water, determine the disinfection concentration with a comparative method, and enter that value as reference value. Follow the instructions described in the chapter Calibration.

Carry out the settings for signal outputs, limits, controller etc. Make sure that all measured values and settings are plausible and correct before you activate the controller.

Finish the start-up with setting the parameters for the automatic sensor cleaning. As start time, select a period of no or constant dosing, and keep in mind that cleaning does not start in low-water situations.

Make sure that measurements, control, and water flow run unimpeded before leaving the instrument!

20.2. Maintenance – operation mode

Never carry out maintenance while the controller is set to automatic. Select either manual mode or Hold.

In the manual mode only the controller is deactivated. All other functions such as the alarm relay and the test functions are still active. This mode is ideally suited to test the wiring to your PLC and to check the alarm functions.

With Hold, all alarm functions are deactivated. This mode is ideally suited to carry out maintenance such as cleaning of filters without issuing an alarm. With Hold, the controller is deactivated, and all analog and digital outputs are frozen to the last value, in case you are using these outputs as inputs for an external control.

20.3. Maintenance of the measurement

Maintenance of the measurement comprises cleaning of the various components, regular testing of safety features and gaskets, regular exchange of consumables, and the regular cross-check and, if necessary, calibration of the measurement.

Note **Maintenance intervals depend on the application, the installation, the accuracy requirements etc.**

Operation	Interval suggestion
Cleaning of sensors and assemblies	2 weeks
Cleaning of valves, filters, tubing etc.	2 weeks
Refill of KCl (with KCl vessels)	Dependent on vessel size
Cross-check of the measurement	Weekly
Calibration of the measurement	Whenever necessary
Checking the gaskets	Weekly
Testing the safety features	2 weeks
Exchange of consumables	Six months / yearly

20.3.1. Cleaning of sensors

Handle and clean sensors very carefully. Always use water and perhaps a soft paper tissue as the first cleaning agent. The metal electrodes of the disinfectant sensors have very smooth surfaces to minimize dirt accumulation. Take care not to roughen these surfaces.

We recommend diluted hydrochloric acid to remove coatings of lime or hydroxides, and commercially available detergents to remove oil and grease. With organic coatings, hydrochloric acid with pepsine or thiourea is usually efficient, especially to open blocked junctions. Ceramic junctions can be cleaned mechanically, even abraded.

Total Chlorine sensors Zirkon® DIS Total should not be cleaned with detergents or acids, nor should the sensors be soaked in cleaning solutions.

Note **Keep your sensors perfectly clean without any manual work with our patented automatic sensor cleaning function ASR®, which ist available for Neon® instruments as add-on. Find more information in the chapter Add-on ASR®. For the time being, ASR is not available for zirkon DIS Total.**

Mind that after cleaning, the measurement takes a while to recover.

20.3.2. Refilling the KCl vessel (with refillable sensors)

When using refillable sensors, make sure that the level of the filling solution is always higher than the water level, and that the internal pressure is always slightly higher than the water pressure, to protect the sensor and to ensure its function.

Regular refilling of the vessel is especially important when the vessel is not visible, for example if it is installed in an immersion-type assembly.

Note **If due to neglected refilling, process water could enter the sensor, see the chapter “Trouble-shooting”.**

20.3.3. Cleaning of assemblies, filters, etc.

An important part of maintenance is the cleaning of all parts that come in contact with the water. Besides the sensors, this includes assemblies, pipes and tubes, filters, flow meters, cocks, valves etc. Coatings, deposits, and biofilm can adulterate the measurement, impede the water flow and at worst even damage the sensor.

Attention **We recommend to use only water and perhaps a soft brush for cleaning. Many synthetic materials are affected by acids or organic solvents!**

The assembly StabiFlow of the measuring system Krypton® DIS is equipped with a filter. To clean the filter, unscrew the inlet, take out the filter and rinse it clean. Take care during reassembly that all components and seals are in their proper position.

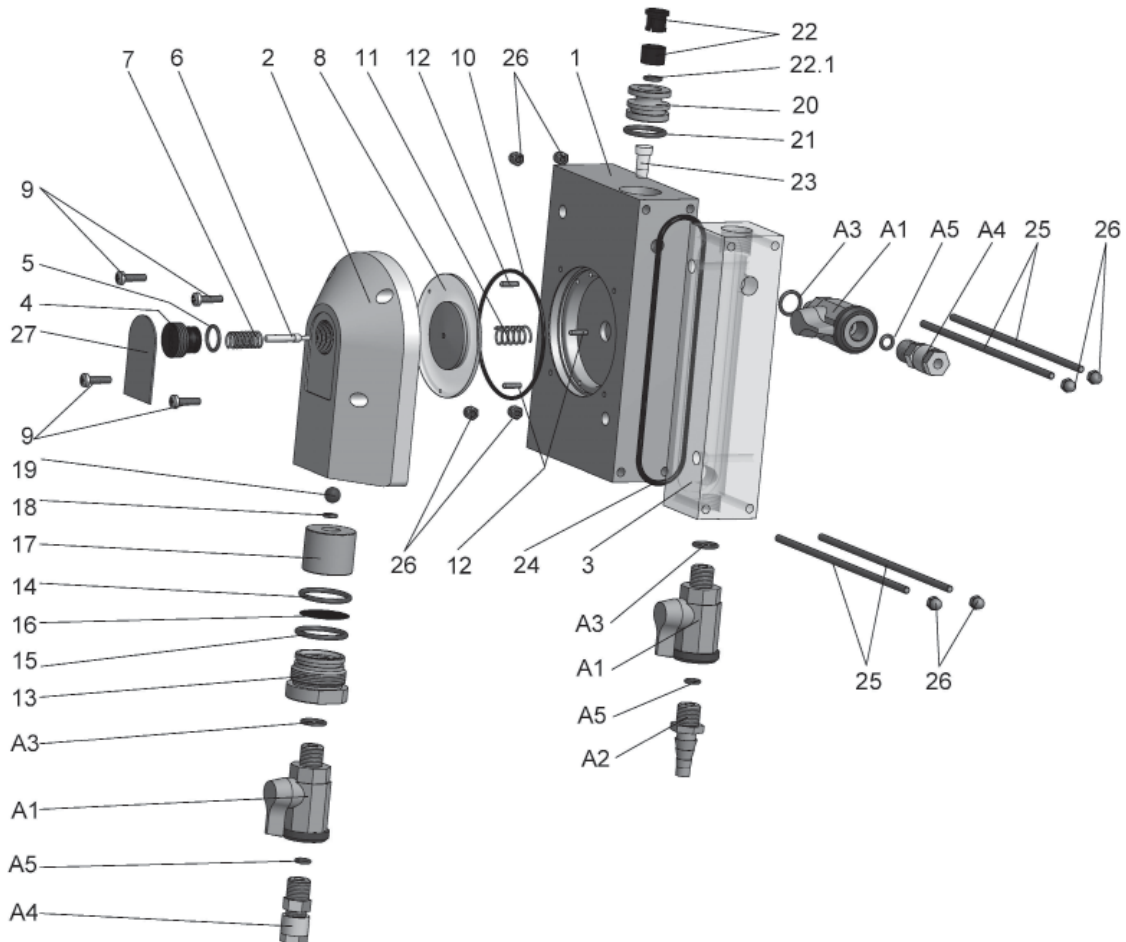

20. Operation and Maintenance of Neon® DIS and Krypton® DIS

No.	Description
1	Main body
2	Membrane chamber (inlet side)
3	Measuring cell Argon®
4	Adjusting screw PG13.5
5	O-ring 12x2
6	Valve pin
7	Coil (inlet side)
8	Assembly group "membrane"
9	Screws Phillips M4x16
10	O-ring 73x2
11	Coil (outlet side)
12	Threaded pins M3x13
13	Hex spud
14	O-ring 26x2
15	O-ring 26x1.5
16	Filter
17	Filter support
18	O-ring 5x1.8
19	Ball
20	Multisensor holder
21	O-ring 19x2.5
22	Quick-lock coupling
23	Float
24	O-ring 108x3
25	Threaded rods M4
26	Dome nuts
27	Label
A1	Stop cock
A2	Hose barb
A3	O-ring 11x3
A4	Tube connector DN 6/8 ¼"
A5	O-ring 6x3

20.3.4. Calibration of the measurement

The response characteristics of sensors change over time, even without use, so the measurement has to be checked against a comparison method at regular intervals and calibrated if the deviation is too pronounced.

The instrument checks the calibration results after calibration and displays an event message if the sensor has to be cleaned, regenerated, or replaced. Refer to Trouble-shooting for more information.

20.3.5. Checking the gaskets

Especially in pressurized applications all gaskets and sealing rings must be checked regularly and replaced at needs. Make sure to use only spare parts consistent with your application and your equipment. Check the proper placement before reapplying pressure!

20.3.6. Testing the safety features

Regularly test all safety features, especially when using control functions. Check the function of water level or flow sensors and verify that the controller is automatically shut down in a low-water situation.

Simulate such an event by impeding the water flow temporarily or by lifting the level sensor out of the water. Switching of the level sensor or loss of the flow signal has to lead to the text message “low water” or “level” or “ext. controller stop” according to settings, and to an automatic controller stop.

Regularly test the function of the alarm relay and ensure that in case of an alarm, the instrument issues the alarm and the connected control center registers the alarm correctly. With the aid of the test menu, such test is easily accomplished.

Note **In the HOLD mode, the alarm function is deactivated.**

20.3.7. Exchange of consumables

Besides the sealing rings and the KCl solution, sensors are typical consumables. The operating life of the sensor depends strongly on the application and the measuring conditions. The info menu of the calibration menu shows the results of the last 10 calibrations which gives you an idea on the condition of your sensor. If the slope approaches the tolerated limit, it can be expected that it will give a calibration error and has to be replaced in the near future.

If you have to exchange a sensor, make sure that the replacement fits your equipment and your application. Remember that you probably have to calibrate when you change a sensor.

Recalibration is also necessary if you exchange the instrument.

Note **Cables also tend to wear out, especially if they are frequently unplugged. Find more information in the chapter “Trouble-Shooting”.**

20.4. Restarting

Restarting is to be carried out like the original start-up. Follow all steps described in this manual.

Before opening the water inlet, make sure that the flow is not impeded or interrupted anywhere. When using assemblies that can hold several sensors, make sure that all holders are occupied or closed with a blind. Make sure that all valves are in the right position (for example, inlet and outlet open, sampling point closed). Check that all screw connections are sealed tight before applying pressure.

20. Operation and Maintenance of Neon® DIS and Krypton® DIS

After installing the sensors, wait until all measurements are stable, and check if the measured values are plausible, before activating the controller. Also check all settings, especially for controller and alarm, and make sure that the feed lines are properly connected and undamaged.

Note **Use all safety features the instrument provides, such as the alarm relay, the limits, the dosage check, and the controller stop.**

20.5. Decommissioning and disposal

If you want to take the measurement out of service for a while, mind the storage conditions listed in the data sheets, especially regarding temperatures. Store sensors always in solution, preferably in 3M KCl, never in deionized water or aggressive solutions. We advise to use for storage the protective covers in which the sensors were delivered. If you want to use other beakers, use plastic instead of glass to avoid damage to the sensors, and ensure that the storage solution always covers the junction.

Store instruments and cables in a cool, dry, and dark place, protected against dust.

If you want to dispose of the instrument permanently, mind that it contains electrical components that have to be disposed of following national directives.

20.6. Facilitating functions

20.6.1. *Store and load settings via SD card*

You can store your settings on an SD card and reload them anytime to ensure that the settings are not lost during maintenance.

This function can also be used to duplicate settings into other instruments of the same type and parameter or to recover your settings after a software update or an upgrade via add-on. Additionally, you can do all settings comfortably on your PC, using the Kuntze configuration software, and then load the settings into the instrument via SD card. The configuration software is available free of charge.

20.6.2. *Software update via SD card*

With the SD card you can also install software updates. Copy the two software files you have received from us onto the SD card (not in a subdirectory). Plug the SD card in the instruments slot, and load the files via SYSTEM → MEMORY → LOAD → SOFTWARE.

20.6.3. *Test menu*

During start-up, or in case of an alarm in your control center inconsistent with the measured values, the test menu will help you test the communication between instrument and control center.

In the test menu you can operate all relays manually, and set fix values for each available mA output.

The test menu can only be used in the Manual mode. The test menu is a submenu of the menu IN/OUT.

21. Trouble-Shooting

In case of an event, the Neon® instrument provides a variety of functions to assist you:

- > Event messages on the display, declaring the nature of the event.
- > An event help containing suggestions how to solve the problem.
- > An event log that stores up to 100 event messages
- > An info menu, showing all settings and current values
- > A reset function to restore factory settings
- > A diagnosis file in case that you need external help. The diagnosis file will allow your contact person to assess the situation.

21.1. Useful accessories for trouble-shooting

- > Radon: Our portable photometer with its convenient case allows a quick and easy comparative measurement. It comes equipped with reagents for the determination of Chlorine, Chlorine dioxide, and Ozone, and can be used to check and calibrate the online measurement.
- > Test plug: With Des meters, the test plug allows a simple test of the measuring input. If you connect the test plug to the cable of the Des sensor, the instrument will show as raw measured value approx. the mV indicated on the plug. The value depends on the parameter and the selected measuring range.

Attention **The measured value on the desktop is generally zero when you connect the test plug since the mV do not fit the measurements!**

- > Spare sensor: Sensors are consumables, and fragile. Exchanging a sensor can speed up trouble-shooting: If the problem remains, it was probably not caused by the sensor. If it has vanished, the sensor needs to be replaced or at least cleaned and regenerated.
- > Spare cable: Cables are frequently causing trouble – damaged contacts or insulations lead to malfunctions very similar to those caused by sensor defects. With a spare cable, such malfunctions can easily be identified and solved.

21.2. Contact

In SYSTEM → CONTACT you can store contact data of a contact person who might help in case of problems. With restricted access (code 0202) this data can be viewed if not altered.

Note **You can have the contact data displayed on the desktop, if you select “contact” as desktop design in the menu SYSTEM → DISPLAY.**

21.3. Diagnosis file

In case of problems, it might be useful to provide an external contact person with an overview of the current situation. To that purpose save the diagnosis file on your SD card. It contains all current values and settings and the eventlog.

21. Trouble Shooting

21.4. Info

The Menu SYSTEM → INFO contains all information on your instrument, the settings, and the current values, such as:

ID

Here you can find the instrument number, the software versions, and the operation hours. This information is important for repair, updates, etc.

Eventlog

The eventlog lists up to 100 events with the times of their appearance and disappearance. Further details are supplied on the following pages.

Settings

This menu lists all settings. In case of trouble, check if all settings are as you had intended, and check if the instruments behavior is consistent with the settings. If for example the alarm relay is not activated when the measured value drops below the lower limit, this might be because you have not activated the lower limit as an alarm action in the alarm action list.

View

This menu shows all current values of analog and digital inputs and outputs, including the raw signals of the sensors. The latter are invaluable for trouble-shooting since they are not affected by any user settings such as calibration, temperature compensation etc. If for example you get a slope error after calibration, even though the raw signals of the sensor were plausible, then the problem might well be a defective or missing temperature measurement, and an exchange of the Des sensor would be quite useless.

The raw data is also especially useful if the instrument has been hopelessly miscalibrated. The information on mA output values and status of the digital inputs help locating communication problems with the control center. mA values can be measured at the terminals of the instrument with an amperemeter.

Note **The mA outputs and the second digital input are add-ons. They are displayed only if the functions have been activated.**

21.5. Event messages

In case of trouble, the instrument displays an event message on the desktop. If there are more than one message, they are displayed alternately.

Not all events will cause the alarm relay to switch. For many events you can decide for yourself if the relay should switch by defining the event as an alarm action in the alarm action list – see Alarm relay.

21.6. Eventlog

Up to 100 events are saved in an eventlog. The *-sign indicates appearance, the #-sign disappearance. Besides the event messages, this also lists power interrupts, calibrations, and similar operations, with date and time.

This helps to interpret events – for example a deviation of the measured value shortly after a power interrupt may simply be due to the unfinished polarization of the measurement.

system	event log
21.08.2012	14:05:23 *start
26.07.2012	21:09:38 #relay 3
26.07.2012	21:09:38 #lower limit
26.07.2012	20:50:05 *relay 3
26.07.2012	20:50:05 #upper limit
19.08.2012	10:15:57 *calibration
19.08.2012	10:11:10 *start

The eventlog provides information on frequency and duration of events. You can see what events have occurred in the past, and how long they lasted. The appearance and disappearance times allow to check what other events had happened at that time, for example the start-up of a dosing pump, frequency inverter, etc.

Note **You can save the eventlog by saving the diagnosis file.**

21.7. Event help

As an addition, the instrument provides help for all events: information on possible causes, and suggestions for possible remedies. These can be found in the menu SYSTEM → EVENT, or – with touch screen instruments – by touching the event message on the desktop.

We advise to follow the suggestions in the order in which they are presented.

Event message	Cause	Suggested remedies
Slope	After calibration, the slope was not within the tolerances	check reference check temperature repeat calibration change sensor

If this message appears, first check what the slope value is. If the value lies between zero and the tolerated minimum, the sensor signal output is too low.

Measuring range	Ideal slope	minimum
Up to 1000 µg/l	100mV/ 0.1 mg	20 mV
Up to 5.00 mg/l	20 mV/ 0.1 mg	4 mV
Up to 10.00 mg/l	10 mV/0.1 mg	2 mV
Up to 20.00 mg/l	5 mV/ 0.1 mg	1 mV
Up to 30.00 mg/l	3,3 mV/ 0.1 mg	0.66 mV
For Zirkon® DIS Total	10 mV/ 0.1 mg	2 mV / 0,1 mg/l

“Ideal slope” refers to the at-works setting. The real slope can vary from that value, depending on measuring conditions, and, with Zirkon® DIS Total, on the substances to be measured. If your slope is too low, switch to a lower measuring range. If the slope is too high, switch to a higher measuring range.

21. Trouble Shooting

If the current slope does not fit the trend of the last calibrations, an error in procedure or settings is more likely.

A low slope can for example be the result of wrong or missing temperature compensation. Also check the current zeropoint displayed in the calibration menu. Especially at low concentrations, an erroneous zeropoint calibration can seriously interfere with the slope calibration. Check the zeropoint in tap water and in a sample of disinfectant-free process water by taking a sample of approx. 0.5-1l in a beaker and stirring the sensor in it. The signal you get will not be very stable, but at least it will give you an idea on whether the zeropoint calibration had been correct or not. If not, recalibrate the zeropoint and repeat the slope calibration.

If the slope is 500, check the raw signal – if this fits the current concentration, most probably somebody has inadvertently carried out a zeropoint calibration at this concentration, making the instrument believe that the same sensor signal corresponds to both zero and a higher calibration, which renders slope determination impossible. Correct the zeropoint calibration and then recalibrate the slope.

If the slope is exactly zero, there was no measuring signal during calibration. This can be caused by lack of measuring water, a cause that should cause an event message in itself, or by a missing contact.

Make sure that a sensor is connected to the instrument, and that the cable is properly connected both to the sensor and to the instrument. To test the proper connection, attach the testplug to the sensor cable and check if the instrument shows as raw value the mV indicated on the plug. If you have no plug, you can test the connection by short-circuiting the two metal electrodes of the DIS sensor, for example by holding a piece of metal wire or a screwdriver to both electrodes – this redirects the instruments internal potentiostat to the measuring input, instantly overloading the input and causing the message “check measuring input” to appear.

If this test fails, disconnect the cable from the instrument and use an Ohmmeter to check the resistance between the measuring electrode (the upper metal ring) to the brown wire, and the counter electrode (the lower metal ring) to the blue wire. Both resistances must be in the 0-10Ohm range to show that the connection is OK. The connection of the reference can also be measured, if you put the Ohmmeter tip to the junction of the DIS sensor, preferably with a piece of wet tissue inbetween; however, here the resistance is in the kOhm range.

If the contacts are all OK, the process water might not contain any disinfectant, possibly due to consumption, or at least not the disinfectant selected as measuring parameter. Here again, take a sample of process water in a beaker and stir the sensor in it. Add some disinfectant manually. The signal will be instable, and the dosing probably quite high, but this provides an easy test to verify that the measurement responds to the disinfectant dosing. When you get the expected reaction, repeat the test with a second sample and add the disinfectant slowly until a strong positive signal occurs. This will tell you something on the disinfectant consumption of your water.

Note **The slope message remains until a new calibration yields values within the tolerances – or until somebody resets all settings to factory settings.**

If calibration problems occur with sensors with refillable reference, the filling solution might be the cause of the problem. If you can, check the reference potential against another reference, for example with a pH- or Redox instrument. The potential should be around 0mV. If not, empty the reference and refill it with fresh 3M KCl solution. Remove any air bubbles from both the sensor and the connected KCl tube.

Event message	Cause	Suggested remedies
Check measuring input	The measuring input receives no proper signal	Check input, check sensor plug, check cable, check sensor

This message appears if the measuring input is overloaded. This can happen during installation, due to the polarisation current that is necessary to condition the sensor, especially in low measuring ranges and with Zirkon® DIS Total. Switch to a higher measuring range to speed up the polarisation process. Switching to a higher range is the measure of choice even when the message appears during operation, since an overload may well be a result of too high concentrations.

If it is not, remove the sensor from the process water to ensure that the fault current is not a result of the installation. If the message remains, it is probably caused by a short-circuit between the measuring and the counter electrode, either within the sensor or within the cable.

Disconnect the sensor from the cable – if the event message remains, disconnect the cable from the instrument. If the message disappears now, exchange the cable. If the message disappears as soon as you disconnect the sensor, the problem lies within the sensor. Dry the sensor and measure the resistance between the two metal electrodes. There should be no connection between them. A short-circuit between the two electrodes redirects the current from the internal potentiostat to the measuring input, causing overload. Such a short-circuit can occur if the sensor body was damaged and water gets into the inner glass rod of the sensor.

Event message	Cause	Suggested remedies
Check temperature input	The temperature input receives no proper signal	Check Pt100/Pt1000 Check cable Without sensor use manual compensation

If the temperature input does not receive an appropriate signal, you may have selected automatic temperature compensation although no temperature sensor is connected. In that case switch to manual compensation. It is also possible that a Pt100 was connected but the compensation was set to Pt1000, or vice versa.

If you have connected a Pt100 or Pt1000, check if you have used the right terminals for connection and the right settings in the temperature menu.

As with the measuring input, a defective cable or sensor can be the cause for this message. You can check temperature sensors with an Ohmmeter – a Pt100 has a resistance of approx. 109 Ohm at room temperature, a Pt1000 approx 1080 Ohm.

Event message	Cause	Suggested remedies
Out of measuring range	Measured values exceed the measuring range	Trend indication only

If the measured value lies outside the measuring range but can still be processed by the instrument, it will be displayed together with this message. Please note that all information on accuracy, linearity, influences of temperature etc specified in the data sheets, only apply to values within the measuring

21. Trouble Shooting

range. Outside this range, the deviations and cross-influences might be higher, and the measurement can only be used as an indication.

If your instrument allows to select from a variety of measuring ranges, select the next higher range.

If the measured value gets so high that it can no longer be processed, the message „check measuring input” will appear.

Event message	Cause	Suggested remedies
Upper limit (or lower limit, respectively)	The measured value is higher than the upper limit (or lower than the lower limit, respectively)	Check dosage check controller parameters keep in mind delay settings

If the measured value exceeds the limits, this might mean that the feeding of control chemicals has been interrupted, because a reagent is empty, or the controller was stopped, or a feed line is damaged.

Warning **If this message was caused by a defective feed line, hazardous chemicals might leak from the break!**

Note **In that case a second message „dosage check“ is probably displayed, if you have activated this function and your controller settings do not impede the function.**

If the message occurs shortly after start-up and possibly quite frequently, please check the settings for control and limits to make sure that they match both each other and the requirements and conditions of your equipment. Perhaps the controller has to be set to slower reactions by choosing a larger proportional range to prevent overdosing.

Note **Temporary limit exceedance that might happen regularly during normal operation can be ignored by setting a delay time in the menu Alarm relay.**

Event message	Cause	Suggested remedies
Digital input 1/2 Low water Level Ext. controller stop	The digital input was closed by a connected sensor or switch	Digital input 1 / low water: check water flow, check sensor/connection Digital input 1 / level: check container level, check sensor/connection

The digital input allows connection of a flow sensor or level sensor or an external switch. According to its intended function, you can assign the digital input one of three different texts: „Low water“ if you have connected a flow or water level sensor, „level“, if you use a level sensor to control the level of a chemical, or „ext. controller stop“, if you use an external switch to activate and deactivate the controller.

Note **Independent of what text you have selected, the controller is automatically shut down whenever the digital input switches.**

Depending on these settings, the suggested remedies differ: If you have selected „low water“ or „level“, the instrument suggests checking the availability of water or reagent, and if that is ok, the proper function of the flow or level sensor.

Note **If you have activated a second digital input, this will lead to similar messages, starting with „digital input 2“.**

Further messages with activated add-ons:

Event message	Cause	Suggested remedies
Cleaning in progress	The automatic cleaning ASR® has just been started.	None

This message appears when the automatic cleaning is carried out. The measured value is frozen to its last value on the desktop and via analog and digital outputs, the controller is deactivated or switched to base-load dosing, according to settings, and the calibration menu is inaccessible. The message disappears automatically as soon as the measurement has returned to normal.

Event message	Cause	Suggested remedies
mA out of range	The current measured value corresponds to an output outside the 0(4)-20mA range	Check settings

This message appears if the measured value is higher than the one assigned to 20mA or lower than the one assigned to 0/4mA.

Example:

You have set the mA output to 0-1mg/l. The output is 0(4)mA at 0mg/l, and 20mA at 1 mg/l. If your measured value is 1.2mg/l, this message will appear.

Check the settings for the analog outputs, and change the settings if necessary.

Event message	Cause	Suggested remedies
Dosage check	Controller output was 100% for longer than the specified time	Check dosing, especially feed lines and pump

Dosage check is a safety measure to shut down the controller in case of defective feed lines to prevent leaks of hazardous chemicals.

The instrument monitors the time of dosing with 100% controller output – if you are using the instruments controller and have activated this function by setting the time to a value >0. If within that time the controller output does not go below 100%, the instrument shuts down the controller, stops the dosing, and displays this message.

So if you read this message on the display, you have to expect problems with the feed lines, including the release of dangerous chemicals!

Warning **The dosage check monitors only those times when the controller is dosing with 100%! If your proportional range is higher than the maximum possible difference between set point and measured value, this condition can never be met!**

21. Trouble Shooting

Finally, there are some event messages indicating fundamental problems that you cannot solve on site:

Event message	Cause	Suggested remedies
Communication error	The internal communication between instrument parts does not work	Contact your supplier
Unknown measurement module	The measurement module does not fit the instrument or does not work properly	Contact your supplier

If such a message appears, the instrument has to be sent in for repair.

21.8. Events with Popup messages

In some events, a window pops up, displaying a message. Just note its contents, or follow the instruction. To close the window, you have to acknowledge with OK.

Popup message	Cause
Check measuring input	The measuring input is overloaded.

If you try to calibrate while the event message „check measuring input“ is displayed and instead of a measured value question marks are displayed, this popup appears. Without a suitable measuring signal calibration is impossible. Refer to the procedures described for the event message “check measuring input”.

Calibration is possible only after the event message has disappeared and regular measured values are displayed.

Popup message	Cause
Check temperature input	During calibration the temperature input receives no signal

If you try to calibrate while the event message „check temperature input“ is displayed and instead of a temperature value question marks are displayed, this popup appears. Without a suitable temperature signal calibration is impossible. Refer to the procedures described for the event message “check temperature input”.

Calibration is possible only after the event message has disappeared and regular temperature values are displayed.

This can be achieved by switching the temperature compensation to manual.

Popup message	Cause	Suggested remedies
SD card error	The instrument cannot use the SD card	No SD card Invalid format Invalid file SD card full

Check if an industry-standard SD card has been plugged into the slot, and that it was plugged properly. If you want to load settings or update files, check that the files are available on the SD card directly and not in a subfolder. Delete and restore the files, if necessary. If you want to store settings on the SD card, check if there is enough storage space left on the card.

This message appears also if you remove the card without deactivating the logger first.

Popup message	Cause	Suggested remedies
No appli	The software files cannot be loaded	Please renew the 2 data files on the SD card and try again.

For updates, both files have to be stored on the SD card, not in a subfolder. Check that the files are available, and delete and restore them if necessary.

Popup message	Cause	Suggested remedies
Memory stop data logging	The SD card is fulll.	SD card full, data logging stopped.

If you have set the logger to STOP mode, then the instrument stops the logging when the SD card is full.

Change the SD card, or remove some of its contents, or select the mode RING to overwrite older data.

Popup message	Cause	Suggested remedies
Check batterie	No or empty batterie	Change batterie

After start-up the instrument checks the batterie. If the batterie is missing or provides to low voltage a popup is shown. In this case please change the batterie.

21.9. Reset

As a last resort it is sometimes necessary to restore factory settings. With the RESET function you erase all settings by operators. Activated add-ons will of course remain activated.

With the Reset function, the system is set to a defined condition. User settings that might severely impede an evaluation of the measured values, such as a calibration gone wrong, are erased.

Index

A

Access level	32
Add-on activation	56
Alarm action	57
Alarm relay	57
action list	58
delay	57
function.....	57
limit values.....	57
settings	57
Analog input	34
Analog output	62
0/4-20mA selection	62
22 mA alarm.....	62
assignment.....	62
range	62
range min/max.....	62
ASR® (automatic sensor cleaning)	63
base load.....	63
cleaning	63
start date	64
start time	63
Autolock	32, 50
Automatic mode	33
Averaging	34

B

Base load during ASR®	63
-----------------------	----

C

Calibration	99
info.....	39
menu	37
reference	37
touch screen.....	51
zeropoint.....	38
Calibration level code	32
Check measuring input	105
Check temperature input	105
Cleaning	63
Cleaning of sensors	96
Code	31
Communication error	108
Connection diagram	19
Contact	
data contact person.....	52
Contact (digital input).....	40
Contrast (display)	48
Controller	82
3-point controller	85
activation and deactivation.....	89
automatic controller stop	90

Controller		Direction	88
configuration of controller output.....	83	Display	48
direction.....	88	Disposal	100
dosage check.....	88	Dosage check	107
manual operation.....	89	Dosing	
ON/OFF controller.....	83	activation and deactivation.....	91
P controller.....	84	automatic dosage stop.....	94
PI controller.....	84	circulation stop delay.....	93
PID controller.....	84	concentration.....	94
start delay.....	88	dosing parameters.....	91
Correction (temperature)	35	flow display.....	94
		pulses.....	91
D		pump output.....	91
Datalog	59	set point.....	92
interval.....	59	E	
start.....	60	Eco mode	50
view.....	61	Event (digital output)	40
Decommissioning	100	Event help	53, 102
Delay (alarm)	57	Eventlog	102
Desktop	48	Event messages	102
Diagnosis file	46, 101	Event-related support	53
Differential time	85	Ext. controller stop	106
Digital input	40	F	
contact.....	40	Facilitating functions	100
event.....	40	Factory settings	55
event message.....	102		
Dimensions	16		

Index

Features	8	M	
Flow display	94	Maintenance	95
Full access code	32	Manual mode	33
		Manual value (temperature)	36
		mA out of range	107
H		mA output	62
Hold	33	22 mA alarm.....	62
Hysteresis	85	Measurement	34
		Memory	42
I		Memory stop data logging	109
Info		Menu overview	28
calibration.....	39	Minimum pulse	87
menu.....	54, 102	Mode (data log)	60
Installation	17	Mode (operation)	33, 95
panel-mounted housing.....	18	Mode (temperature compensation)	36
wall-mounted housing.....	18	Motor run time	87
Integral time	84		
Interval (datalog)	59	N	
		No appli	109
L			
Language	47	O	
Level	106	Operating hours	54
Limits	47, 106	Operation	24
Load settings	42	Operation mode	33
Load Software	45	Out of measuring range	105
Log para	59		
Log set	59	P	
Lower limit	106	Popup messages	108
Low water	106		

P range	84	Settings	
Pt100	35	alarm relay.....	57
Pt1000	35	datalog.....	59
Pulse-frequency	87	display	48
Pulse pause	87	how to load	44
		how to save	43
R		menu	25
Range (mA outputs)	62	overview	54
Raw signals	101	store and load.....	42, 100
Reference	37	Slope	103
Reference (temperature compensation)	36	Software update	45, 100
Registration range (mA outputs)	62	Software version	54
Reset	55	Start delay (controller)	88
Restarting	99	System functions	47
Restoring factory settings	101		
		T	
S		Technical Data	15
S1 control	83	Temperature compensation	36
S1/S2 control	83	reference temperature.....	36
S2 control	83	Temperature measurement	35
Save		correction	35
diagnosis file	46	sensor type.....	35
settings	44	Test menu	41, 100
SD card	43	Text	51
SD card error	109	Time	47
Serial number	54	Touch calibration	51
Set point	83	Trouble-Shooting	101
		Type (temperature measurement)	35

Index

U

Unknown measurement module 108

Upper limit 57

V

View 102

raw signals 54

W

Warranty 9

Z

Zoom (mA output) 62



Kuntze Instruments GmbH
Robert-Bosch-Str. 7a | 40668 Meerbusch | Germany | Fon +49 (02150) 70 66-0 | Fax +49 (02150) 70 66-60
info@kuntze.com | www.kuntze.com